

PIPE UNIONS ROHRVERBINDUNGEN



02 PIPE UNIONS
 ROHRVERBINDUNGEN



03 FITTINGS
 ROHRFORMSTÜCKE

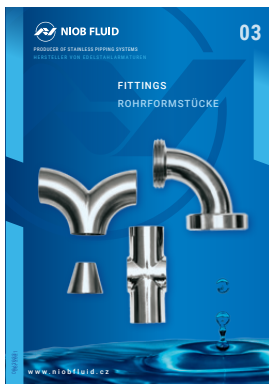

04 VALVES AND COCKS
 VENTILE UND HÄHNNE



05 SPECIAL FITTINGS AND PARTS
 SPEZIALARMATUREN UND TEILE



06 DOORS AND MANWAYS
 MANNLOCHTÜREN UND KLAPPTÜREN



07 ACCESSORIES
 ZUBEHÖR



08 DOUBLE-WALLED PIPING SYSTEMS
 DOPPELWANDIGE ROHRSYSTEME



09 ASEPTIC PROGRAM
 ASEPTISCHES PROGRAMM



The company NIOB FLUID s. r. o. is a manufacturer focused on the production of fasteners, shut-off and control valves of stainless steels. These valves are especially designed for the transport of liquids in the food, chemical and the pharmaceutical industry. It is simultaneously also the supplier of pipe fittings and other parts needed for piping systems and components for tanks such as the lid, manwaydoor, level indicator and other components.

Die Gesellschaft NIOB FLUID s.r.o. ist ein Hersteller, der auf die Produktion von Verbindungs-, Absperr- und Reguliervorgängen aus Edelstahl orientiert ist. Diese Armaturen sind vor allem für den Transport von Flüssigkeiten in der Lebensmittel- und Chemieindustrie und in der Pharmazie bestimmt. Die Gesellschaft ist gleichzeitig auch Lieferant von Rohrverbindungsstücken und weiteren Teilen, die für die Rohrleitungen erforderlich sind, und von Behälterteilen wie Hauben, Luken, Standgläser und weitere Komponenten.

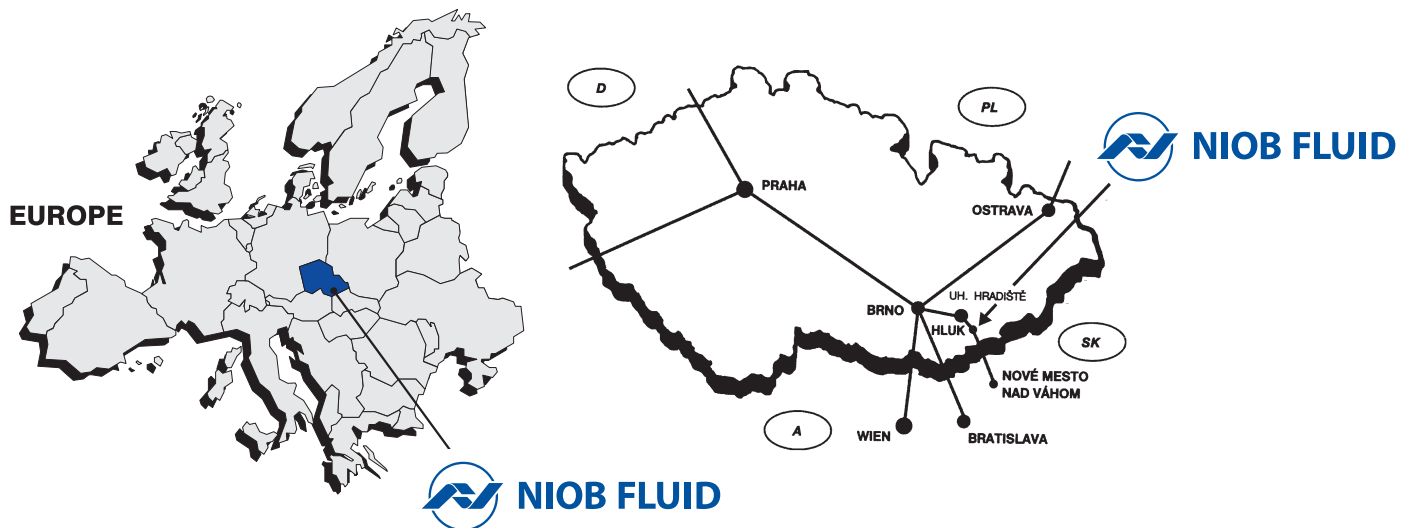

NIOB FLUID s. r. o.
Ostrožská 1003, 687 25 Hluk, Czech Republic
Phone: +420 572 419 822 – 8, Fax: +420 572 419 868
E-mail: marketing@niobfluid.cz, www.niobfluid.cz

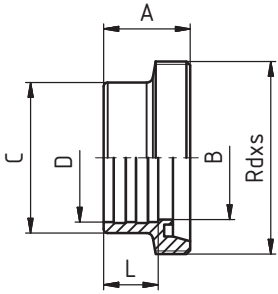
Expanding male Einwalzgewindestutzen	20010	Dimensions • Baumaße										
	DIN 11 851	DN	A	B	C	D	E	F	R	L	thread DIN 405 Rd x s	kg
		25	29	26	35	28,2				15	52x1/6"	0,16
		32	32	32	41	34,2				18	58x1/6"	0,19
		40	33	38	48	40,3				20	65x1/6"	0,24
		50	35	50	61	52,3				22	78x1/6"	0,34
		65	40	66	79	70,4				25	95x1/6"	0,51
		80	45	81	93	85,4				28	110x1/4"	0,72

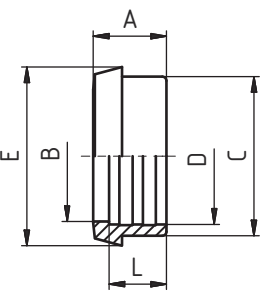
Expanding liner Einwalzkegelstutzen	20020	Dimensions • Baumaße										
	DIN 11 851	DN	A	B	C	D	E	F	R	L	thread DIN 405 Rd x s	kg
		25	22	26	35	28,2	44			15		0,09
		32	25	32	41	34,2	50			18		0,12
		40	26	38	48	40,3	56			20		0,15
		50	28	50	61	52,3	68,5			22		0,22
		65	32	66	79	70,4	86			25		0,32
		80	37	81	93	85,4	100			28		0,40

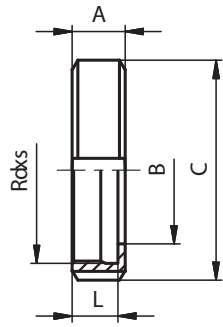
Nut Nutmutter	20030	Dimensions • Baumaße										
	DIN 11 851	DN	A	B	C	D	E	F	R	L	thread DIN 405 Rd x s	kg
		10	18	19	38					15	28x1/8"	0,07
		15	18	25	44					15	34x1/8"	0,08
		20	20	31	54					17	44x1/6"	0,14
		25	21	36	63					18	52x1/6"	0,18
		32	21	42	70					18	58x1/6"	0,22
		40	21	49	78					18	65x1/6"	0,25
		50	22	62	92					19	78x1/6"	0,33
		65	25	80	112					21	95x1/6"	0,55
		80	29	94	127					25	110x1/4"	0,80
		100	31	115	148					26	130x1/4"	1,08
		125	35	138	178					30	160x1/4"	1,45
		150	40	164	210					34	190x1/4"	1,88

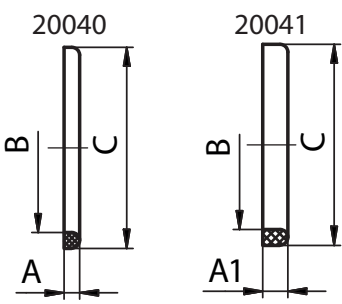
Gasket Dichtung	20040	20041	Dimensions • Baumaße											
	DIN 11 851		DN	A	A1	B	C	E	F	R	L	thread DIN 405 Rd x s	kg	
			10	4	-	12	20						0,0012	
			15	4	-	18	26							0,0016
			20	4	-	23	33							0,0026
			25	5	8	30	40							0,0036
			32	5	8	36	46							0,0040
			40	5	8	42	52							0,0048
			50	5	8	54	64							0,0062
			65	5	8	71	81							0,0070
			80	5	8	85	95							0,0080
			100	6	8	104	114							0,0134
			125	7	8	130	142							0,0236
			150	7	8	155	167							0,0276

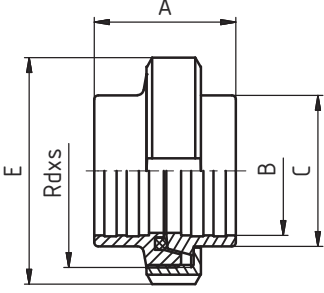
Expanding union - complete Einwalzverschraubung - komplett	20090	Dimensions • Baumaße										
	DIN 11 851	DN	A	B	C	D	E	F	R	L	thread DIN 405 Rd x s	kg
	25	45	28,2	35		63					52x1/6"	0,16
	32	51	34,2	41		70					58x1/6"	0,19
	40	53	40,3	48		78					65x1/6"	0,24
	50	57	52,3	61		92					78x1/6"	0,34
	65	65	70,4	79		112					95x1/6"	0,51
	80	75	85,4	93		127					110x1/4"	0,72

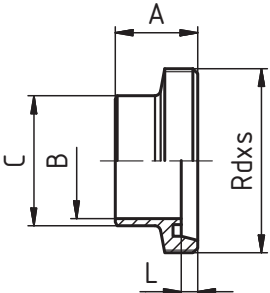
Welding male Anschweißgewindestutzen	20100	Dimensions • Baumaße										
	DIN 11 851	DN	A	B	C	D	E	F	R	L	thread DIN 405 Rd x s	kg
	10	21	10	15						4	28 x 1/8"	0,044
	15	21	16	21						4	34 x 1/8"	0,046
	20	24	20	25						6	44 x 1/6"	0,084
	25	29	26	31						7	52 x 1/6"	0,104
	32	32	32	37						7	58 x 1/6"	0,112
	40	33	38	43						7	65 x 1/6"	0,164
	50	35	50	55						7	78 x 1/6"	0,296
	65	40	66	72						8	95 x 1/6"	0,280
	80	45	81	87						8	110 x 1/4"	0,540
	100	54	100	106						10	130 x 1/4"	0,780
	125	46	125	132						12	160 x 1/4"	1,140
	150	50	150	157						13	190 x 1/4"	1,800

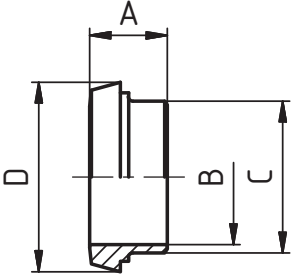
Welding liner Anschweißkegelstutzen	20110	Dimensions • Baumaße										
	DIN 11 851	DN	A	B	C	D	E	F	R	L	thread DIN 405 Rd x s	kg
	10	17	10	15	22,5							0,060
	15	17	16	21	28,5							0,062
	20	18	20	25	36,5							0,100
	25	22	26	31	44							0,120
	32	25	32	37	50							0,160
	40	26	38	43	56							0,165
	50	28	50	55	68,5							0,220
	65	32	66	72	86							0,320
	80	37	81	87	100							0,400
	100	44	100	106	121							0,600
	125	34	125	132	150							0,930
	150	37	150	157	176							1,060

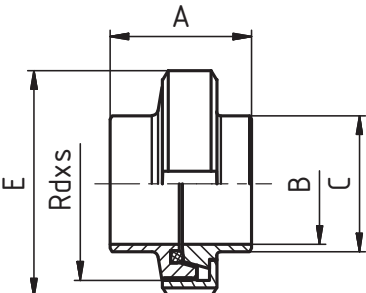
Welding union - complete Anschweißverschraubung - komplett	20120	Dimensions • Baumaße										
	DIN 11 851	DN	A	B	C	D	E	F	R	L	thread DIN 405 Rd x s	kg
	10	35	10	15		38					28 x 1/8"	0,17
	15	35	16	21		44					34 x 1/8"	0,18
	20	37	20	25		54					44 x 1/6"	0,32
	25	45	26	31		63					52 x 1/6"	0,40
	32	51	32	37		70					58 x 1/6"	0,49
	40	53	38	43		78					65 x 1/6"	0,58
	50	57	50	55		92					78 x 1/6"	0,84
	65	65	66	72		112					95 x 1/6"	1,15
	80	75	81	87		127					110 x 1/4"	1,74
	100	89	100	106		148					130 x 1/4"	2,46
	125	69	125	132		178					160 x 1/4"	3,52
	150	74	150	157		210					190 x 1/4"	4,74

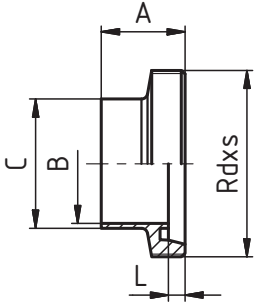
Welding male Anschweißgewindestutzen	20100 R	Dimensions • Baumaße										
	DIN 11 851	DN	A	B	C	D	E	F	R	L	thread DIN 405 Rd x s	kg
	10	21	10	13						4	28 x 1/8"	0,04
	15	21	16	19						4	34 x 1/8"	0,05
	20	24	20	23						6	44 x 1/6"	0,09
	25	29	26	29						7	52 x 1/6"	0,11
	32	32	32	35						7	58 x 1/6"	0,13
	40	33	38	41						7	65 x 1/6"	0,16
	50	35	50	53						7	78 x 1/6"	0,22
	65	40	66	70						8	95 x 1/6"	0,35
	80	45	81	85						8	110 x 1/4"	0,52
	100	54	100	104						10	130 x 1/4"	0,67
	125	46	125	129						12	160 x 1/4"	0,99
	150	50	150	154						13	190 x 1/4"	1,71

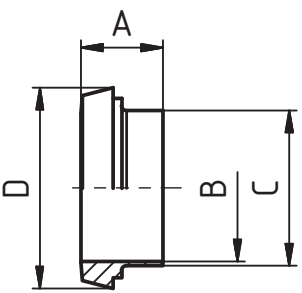
Welding liner Anschweißkegelstutzen	20110 R	Dimensions • Baumaße										
	DIN 11 851	DN	A	B	C	D	E	F	R	L	thread DIN 405 Rd x s	kg
	10	17	10	13	22,5							0,02
	15	17	16	19	28,5							0,03
	20	18	20	23	36,5							0,06
	25	22	26	29	44							0,08
	32	25	32	35	50							0,10
	40	26	38	41	56							0,12
	50	28	50	53	68,5							0,17
	65	32	66	70	86							0,29
	80	37	81	85	100							0,35
	100	44	100	104	121							0,57
	125	34	125	129	150							0,77
	150	37	150	154	176							1,01

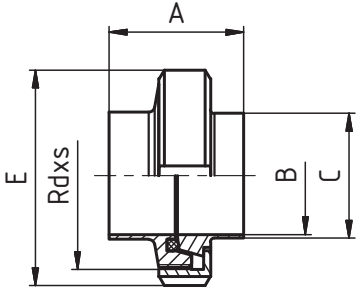
Welding union - complete Anschweißverschraubung - komplett	20120 R	Dimensions • Baumaße										
	DIN 11 851	DN	A	B	C	D	E	F	R	L	thread DIN 405 Rd x s	kg
	10	35	10	13		38					28 x 1/8"	0,13
	15	35	16	19		44					34 x 1/4"	0,16
	20	37	20	23		54					44 x 1/6"	0,28
	25	45	26	29		63					52 x 1/6"	0,37
	32	51	32	35		70					58 x 1/6"	0,45
	40	53	38	41		78					65 x 1/6"	0,53
	50	57	50	53		92					78 x 1/6"	0,67
	65	65	66	70		112					95 x 1/6"	1,19
	80	75	81	85		127					110 x 1/4"	1,67
	100	89	100	104		148					130 x 1/4"	2,32
	125	69	125	129		178					160 x 1/4"	3,21
	150	74	150	154		210					190 x 1/4"	4,60

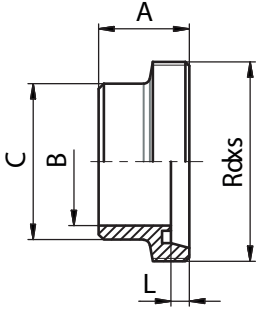
Welding male Anschweißgewindestutzen	20100 T	Dimensions • Baumaße										
		DN	A	B	C	D	E	F	R	L	thread DIN 405 Rd x s	kg
		10	21	10	18					4	28x1/8"	0,05
		15	21	16	24					4	34x1/8"	0,07
		20	24	20	30					6	44x1/6"	0,13
		25	29	26	35					7	52x1/6"	0,17
		32	32	32	41					7	58x1/6"	0,21
		40	33	38	48					7	65x1/6"	0,27
		50	35	50	61					7	78x1/6"	0,38
		65	40	66	79					8	95x1/6"	0,61
		80	45	81	93					8	110x1/4"	0,86
		100	54	100	114					10	130x1/4"	1,15

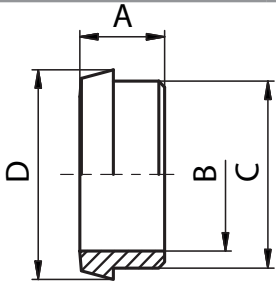
Welding liner Anschweißkegelstutzen	20110 T	Dimensions • Baumaße										
		DN	A	B	C	D	E	F	R	L	thread DIN 405 Rd x s	kg
		10	17	10	18	22,5						0,03
		15	17	16	24	28,5						0,04
		20	18	20	30	36,5						0,07
		25	22	26	35	44						0,10
		32	25	32	41	50						0,14
		40	26	38	48	56						0,17
		50	28	50	61	68,5						0,25
		65	32	66	79	86						0,42
		80	37	81	93	100						0,54
		100	44	100	114	121						0,89

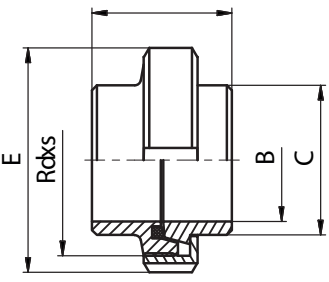
Welding union - complete Anschweißverschraubung - komplett	20120 T	Dimensions • Baumaße										
		DN	A	B	C	D	E	F	R	L	thread DIN 405 Rd x s	kg
		10	35	10	18		38				28x1/8"	0,19
		15	35	16	24		44				34x1/4"	0,19
		20	37	20	30		54				44x1/6"	0,34
		25	45	26	35		63				52x1/6"	0,45
		32	51	32	41		70				58x1/6"	0,57
		40	53	38	48		78				65x1/6"	0,69
		50	57	50	61		92				78x1/6"	0,96
		65	65	66	79		112				95x1/6"	1,58
		80	75	81	93		127				110x1/4"	2,20
		100	89	100	114		148				130x1/4"	3,12

Reducing male part Reduziergewindestutzen	20230	Dimensions • Baumaße											
		DN	A	B	C	D	E	F	R	L	thread DIN 405 Rd x s	kg	
		20/10	24	10	13		20					44x1/6"	
		20/15	24	16	19		20					44x1/6"	
		25/10	29	10	13		26					52x1/6"	
		25/15	29	16	19		26					52x1/6"	
		25/20	29	20	23		26					52x1/6"	
		32/15	32	16	19		32					58x1/6"	
		32/20	32	20	23		32					58x1/6"	
		32/25	32	26	29		32					58x1/6"	
		40/20	33	20	23		38					65x1/6"	
		40/25	33	26	29		38					65x1/6"	
		40/32	33	32	35		38					65x1/6"	
		50/20	35	20	23		50					78x1/6"	
		50/25	35	26	29		50					78x1/6"	
		50/32	35	32	35		50					78x1/6"	
		50/40	35	38	41		50					78x1/6"	
		65/40	40	38	41		66					95x1/6"	
		65/50	40	50	53		66					95x1/6"	
		80/40	45	38	41		81					110x1/4"	
		80/50	45	50	53		81					110x1/4"	
		80/65	45	66	70		81					110x1/4"	
		100/50	54	50	53		100					130x1/4"	
		100/65	54	66	70		100					130x1/4"	
		100/80	54	81	85		100					130x1/4"	

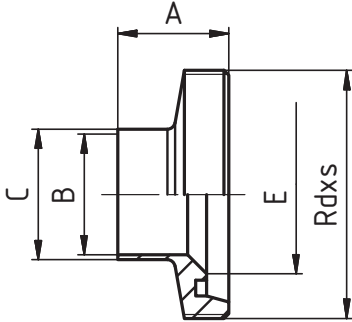

Reducing liner Reduzierkegelstutzen	20240	Dimensions • Baumaße											
		DN	A	B	C	D	E	F	R	L	thread DIN 405 Rd x s	kg	
		20/10	18	10	13	36,5	20						
		20/15	18	16	19	36,5	20						
		25/10	22	10	13	44	26						
		25/15	22	16	19	44	26						
		25/20	22	20	23	44	26						
		32/15	25	16	19	50	32						
		32/20	25	20	23	50	32						
		32/25	25	26	29	50	32						
		40/20	26	20	23	56	38						
		40/25	26	26	29	56	38						
		40/32	26	32	35	56	38						
		50/20	28	20	23	68,5	50						
		50/25	28	26	29	68,5	50						
		50/32	28	32	35	68,5	50						
		50/40	28	38	41	68,5	50						
		65/40	32	38	41	86	66						
		65/50	32	50	53	86	66						
		80/40	37	38	41	100	81						
		80/50	37	50	53	100	81						
		80/65	37	66	70	100	81						
		100/50	44	50	53	121	100						
		100/65	44	66	70	121	100						
		100/80	44	81	85	121	100						

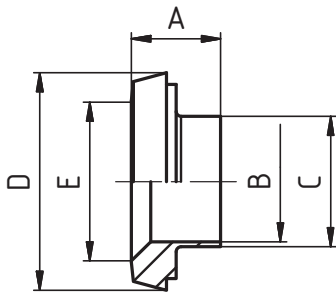

Blind nut Blindmutter	20250	Dimensions • Baumaße											
		DN	A	B	C	D	E	F	R	L	thread DIN 405 Rd x s	kg	
		10	18	15			38					28x1/8"	0,08
		15	18	15			44					34x1/8"	0,10
		20	20	17			54					44x1/6"	0,14
		25	21	18			63					52x1/6"	0,19
		32	21	18			70					58x1/6"	0,23
		40	21	18			78					65x1/6"	0,26
		50	22	19			92					78x1/6"	0,38
		65	25	21			112					95x1/6"	0,66
		80	29	25			127					110x1/4"	1,00
		100	31	26			148					130x1/4"	1,40
		125	35	30			178					160x1/4"	1,97
		150	40	34			210					190x1/4"	2,87

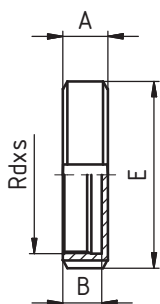

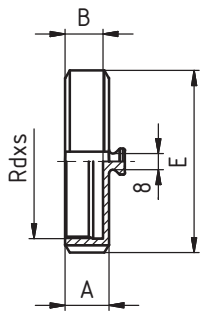
Blind nut with boss Blindmutter mit knopf	20260	Dimensions • Baumaße										
		DN	A	B	C	D	E	F	R	L	thread DIN 405 Rd x s	kg
	10	18	15			38					28x1/8"	0,09
	15	18	15			44					34x1/8"	0,11
	20	20	17			54					44x1/6"	0,15
	25	21	18			63					52x1/6"	0,20
	32	21	18			70					58x1/6"	0,24
	40	21	18			78					65x1/6"	0,27
	50	22	19			92					78x1/6"	0,39
	65	25	21			112					95x1/6"	0,67
	80	29	25			127					110x1/4"	1,01
	100	31	26			148					130x1/4"	1,41
	125	35	30			178					160x1/4"	1,98
	150	40	34			210					190x1/4"	2,88

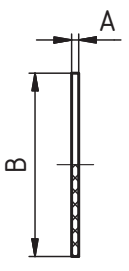
Gasket disc - blind nut Dichtscheibe - blindmutter	20270	Dimensions • Baumaße										
		DN	A	B	C	D	E	F	R	L	thread DIN 405 Rd x s	kg
	10	3	28									
	15	3	34									
	20	3	44									
	25	3	52									
	32	3	58									
	40	3	65									
	50	3	78									
	65	3	95									
	80	3	110									
	100	3	130									
	125	4	160									
	150	4	190									

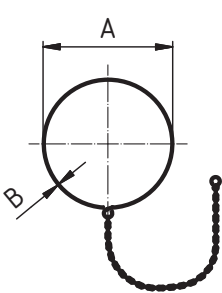
Chain with hook and eye Kette mit haken und öse	20280	Dimensions • Baumaße										
		DN	A	B	C	D	E	F	R	L	thread DIN 405 Rd x s	kg
	10	18	1,25									
	15	24	1,25									
	20	28	1,25									
	25	34	1,25									
	32	41	1,25									
	40	46	1,25									
	50	57	1,25									
	65	75	1,4									
	80	93	1,6									
	100	113	1,6									
	125	136	3									
	150	166	3									

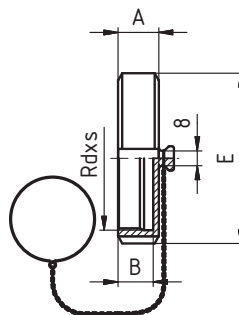
Blind nut - complete Blindmutter (komplett)	20290	Dimensions • Baumaße										
		DN	A	B	C	D	E	F	R	L	thread DIN 405 Rd x s	kg
	10	18	15			38					28x1/8"	0,12
	15	18	15			44					34x1/8"	0,15
	20	20	17			54					44x1/6"	0,19
	25	21	18			63					52x1/6"	0,25
	32	21	18			70					58x1/6"	0,29
	40	21	18			78					65x1/6"	0,33
	50	22	19			92					78x1/6"	0,46
	65	25	21			112					95x1/6"	0,85
	80	29	25			127					110x1/4"	1,11
	100	31	26			148					130x1/4"	1,53
	125	35	30			178					160x1/4"	2,12
	150	40	34			210					190x1/4"	3,05

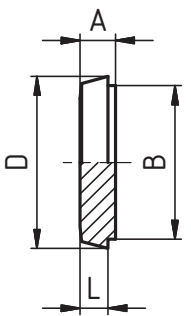
Liner blank Blindkegel	20300	Dimensions • Baumaße									
		DN	A	B	C	D	E	F	R	L	thread DIN 405 Rd x s
	10	9	18		22,5				6		0,02
	15	9	24		28,5				6		0,04
	20	11	30		36,5				8		0,07
	25	13	35		44				10		0,13
	32	13	41		50				10		0,17
	40	13	48		56				10		0,22
	50	14	61		68,5				11		0,35
	65	16	79		86				12		0,67
	80	16	93		100				12		0,92
	100	20	114		121				15		1,34
	125	22	137		150				17		1,68
150	24	163		176				18		4,30	

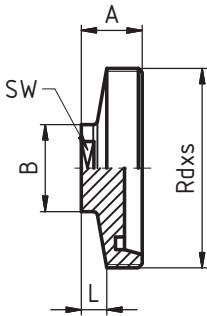
Male part blank Blindgewinde	20330	Dimensions • Baumaße									
		DN	A	B	C	D	E	F	L	SW	thread DIN 405 Rd x s
	10	22	22					10	19	28x1/8"	0,06
	15	22	25					10	22	34x1/8"	0,09
	20	24	25					10	22	44x1/6"	0,13
	25	24	34					10	27	52x1/6"	0,19
	32	24	34					10	27	58x1/6"	0,22
	40	24	34					10	27	65x1/6"	0,25
	50	24	34					10	27	78x1/6"	0,35
	65	28	34					10	27	95x1/6"	0,64
	80	30	34					10	27	110x1/4"	1,30
	100	30	34					10	27	130x1/4"	2,10

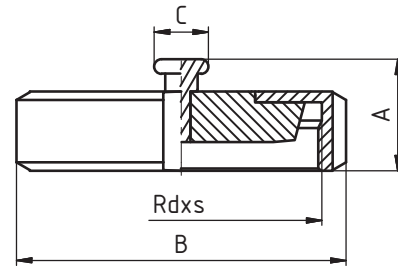
Blind nut with liner blank (complete) Blindmutter mit blindkegel (komplett)	20340	Dimensions • Baumaße									
		DN	A	B	C	D	E	F	L	SW	thread DIN 405 Rd x s
	10	27	38	15						28x1/8"	0,12
	15	27	44	15						34x1/8"	0,15
	20	29	54	15						44x1/6"	0,22
	25	30	63	15						52x1/6"	0,32
	32	30	70	15						58x1/6"	0,40
	40	30	78	15						65x1/6"	0,49
	50	31	92	15						78x1/6"	0,73
	65	34	112	20						95x1/6"	1,25
	80	38	127	20						110x1/4"	1,70
	100	40	148	20						130x1/4"	2,79
	125	44	178	20						160x1/4"	4,39
150	49	210	20						190x1/4"	6,54	

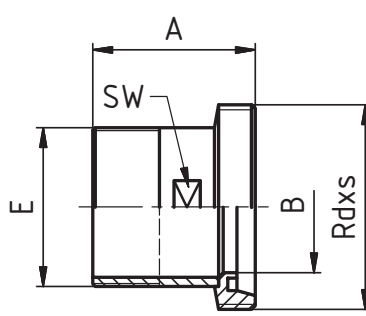
Male threaded outside Einschraub gewindestutzen	20350	Dimensions • Baumaße									
		DN	A	B	C	D	E	F	R	SW	thread DIN 405 Rd x s
	10	40	10			3/8"			15	28x1/8"	0,06
	15	43	16			1/2"			20	34x1/8"	0,09
	20	47	20			3/4"			25	44x1/6"	0,15
	25	52	26			1"			32	52x1/6"	0,21
	25	54	26			3/4"			25	52x1/6"	0,20
	32	54	32			1"			32	58x1/6"	0,23
	32	54	32			1 1/4"			40	58x1/6"	0,25
	40	54	38			1 1/2"			45	65x1/6"	0,32
	50	57	50			2"			57	78x1/6"	0,43
	65	66	66			2 1/2"			73	95x1/6"	0,65
	80	75	81			3"			86	110x1/4"	1,00
100	83	100			4"			110	130x1/4"	1,33	

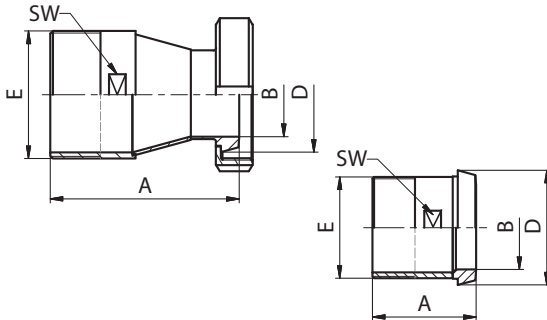
Liner threaded outside Einschraub kegelstutzen	20360	Dimensions • Baumaße										
		DN	A	B	C	D	E	F	R	SW	thread DIN 405 Rd x s	kg
	10	37	10		22,5	3/8"				15		0,04
	15	40	16		28,5	1/2"				20		0,06
	20	47	20		36,5	3/4"				25		0,11
	25	50	26		44	1"				32		0,16
	32	54	32		50	1 1/4"				40		0,19
	40	54	38		56	1 1/2"				45		0,25
	50	57	50		68,5	2"				57		0,35
	65	66	66		86	2 1/2"				73		0,55
	80	75	81		100	3"				86		0,72
	100	83	100		121	4"				110		1,12

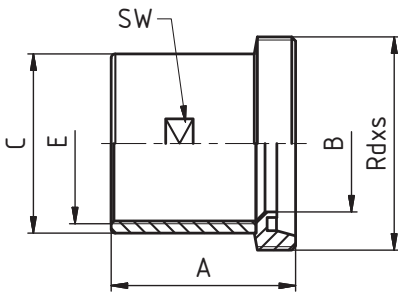
Male threaded inside Aufschraub gewindestutzen	20370	Dimensions • Baumaße										
		DN	A	B	C	D	E	F	R	SW	thread DIN 405 Rd x s	kg
	10	31	10	20,5		3/8"				19	28x1/8"	0,06
	15	31	16	25		1/2"				24	34x1/8"	0,08
	20	35	20	32		3/4"				30	44x1/6"	0,15
	25	38	26	37		1"				35	52x1/6"	0,19
	32	40	32	46		1 1/4"				44	58x1/6"	0,23
	40	41	38	52,5		1 1/2"				51	65x1/6"	0,28
	50	43	50	65,5		2"				63	78x1/6"	0,41
	65	50	66	81		2 1/2"				78	95x1/6"	0,60
	80	56	81	95		3"				92	110x1/4"	0,92
	100	55	100	125		4"				120	130x1/4"	1,32

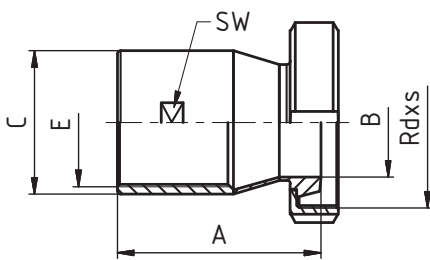
Liner threaded inside Aufschraub kegelstutzen	20380	Dimensions • Baumaße										
		DN	A	B	C	D	E	F	R	SW	thread DIN 405 Rd x s	kg
	10	44	10	20,5		3/8"				19	28x1/8"	0,13
	15	50	16	25		1/2"				24	34x1/8"	0,17
	20	53	20	32		3/4"				30	44x1/6"	0,26
	25	53	26	37		1"				35	52x1/6"	0,35
	32	60	32	46		1 1/4"				44	58x1/6"	0,43
	40	65	38	52,5		1 1/2"				51	65x1/6"	0,52
	50	67	50	65,5		2"				63	78x1/6"	0,75
	65	76	66	81		2 1/2"				78	95x1/6"	1,27
	80	80	81	95		3"				92	110x1/4"	1,62
	100	100	100	125		4"				120	130x1/4"	2,54

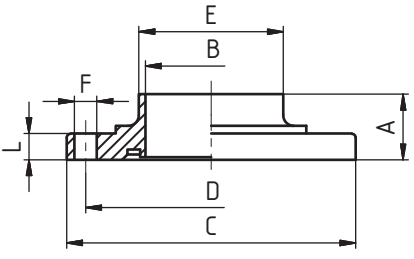
Flange PN 10 with groove Kleinflansch PN mit nut	20400		Dimensions • Baumaße								
	DN	A	B	C	D	E	F	R	L	kg	
	10	20	10	62	44	15	8,5x4		10	0,20	
	15	20	16	68	50	21	8,5x4		10	0,26	
	20	20	20	75	59	25	8,5x4		10	0,29	
	25	20	26	87	73	31	8,5x4		10	0,39	
	32	20	32	92	78	37	8,5x4		10	0,46	
	40	25	38	97	82,5	43	8,5x4		10	0,47	
	50	25	50	110	95,5	55	8,5x4		10	0,59	
	65	25	66	127	112,5	72	8,5x4		10	0,75	
	80	30	81	142	127,5	87	8,5x4		16	1,28	
	100	30	100	162	147,5	106	8,5x4		16	1,72	
	125	40	125	200	180	132	11x6		16	2,87	
	150	45	150	230	210	157	11x6		16	3,85	

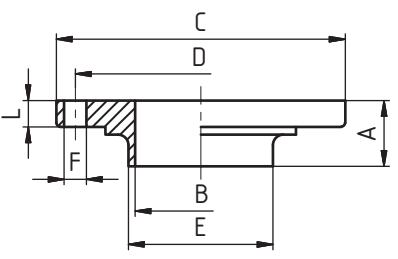
Flange PN 10 without groove Kleinflansch PN ohne nut	20410		Dimensions • Baumaße								
	DN	A	B	C	D	E	F	R	L	kg	
	10	20	10	62	44	15	8,5x4		10	0,20	
	15	20	16	68	50	21	8,5x4		10	0,26	
	20	20	20	75	59	25	8,5x4		10	0,29	
	25	20	26	87	73	31	8,5x4		10	0,39	
	32	20	32	92	78	37	8,5x4		10	0,46	
	40	25	38	97	82,5	43	8,5x4		10	0,47	
	50	25	50	110	95,5	55	8,5x4		10	0,59	
	65	25	66	127	112,5	72	8,5x4		10	0,75	
	80	30	81	142	127,5	87	8,5x4		16	1,28	
	100	30	100	162	147,5	106	8,5x6		16	1,72	
	125	40	125	200	180	132	11x6		16	2,87	
	150	45	150	230	210	157	11x6		16	3,85	

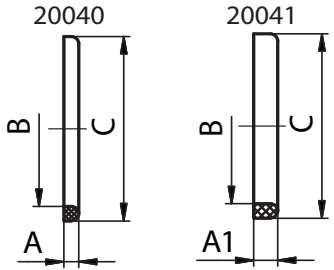
Gasket Dichtring	20040		20041		Dimensions • Baumaße						
	DN	A	A1	B	C	kg	F	R	L	thread DIN 405 Rd x s	kg
	10	4		12	20	0,0012					0,0012
	15	4		18	26	0,0016					0,0016
	20	4		23	33	0,0026					0,0026
	25	5	8	30	40	0,0036					0,0036
	32	5	8	36	46	0,0040					0,0040
	40	5	8	42	52	0,0048					0,0048
	50	5	8	54	64	0,0062					0,0062
	65	5	8	71	81	0,0070					0,0070
	80	5	8	85	95	0,0080					0,0080
	100	6	8	104	114	0,0134					0,0134
	125	7	8	130	142	0,0236					0,0236
	150	7	8	155	167	0,0276					0,0276

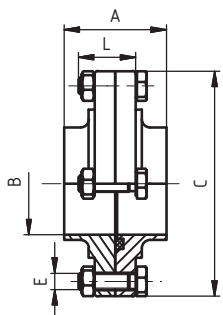
Flange connection PN 10 - complete Flanschverbindung PN 10 - komplett	20420		Dimensions • Baumaße								
	DN	A	B	C	D	E	F	R	L	thread DIN 405 Rd x s	kg
	10	40	10	62		4 x M8			28		0,40
	15	40	16	68		4 x M8			28		0,52
	20	40	20	75		4 x M8			28		0,58
	25	40	26	87		4 x M8			28		0,78
	32	40	32	92		4 x M8			28		0,92
	40	50	38	97		4 x M8			28		0,94
	50	50	50	110		4 x M8			28		1,18
	65	50	66	127		4 x M8			28		1,50
	80	60	81	142		4 x M8			40		2,56
	100	60	100	162		4 x M8			40		3,44
	125	80	125	200		6 x M10			45		5,74
	150	90	150	230		6 x M10			45		7,70

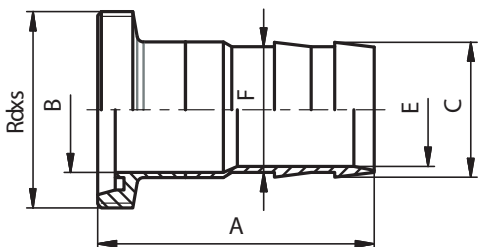
Liner hose fitting - P Schlauchstutzen - G	20510	Dimensions • Baumaße										
		DN	A	B	C	D	E	F	R	L	thread DIN 405 Rd x s	kg
	10	60	10	12		7	10				28x1/8"	0,05
	15	61	16	18,5		13	15				34x1/8"	0,08
	20	65	20	23		16	20				44x1/6"	0,17
	25	70	26	28		20	25				52x1/6"	0,23
	32	84	32	35,6		27	32				58x1/6"	0,33
	40	95	38	43,6		35	40				65x1/6"	0,52
	50	110	50	53,6		45	50				78x1/6"	0,66
	65	133	66	66,6		58	65				95x1/6"	1,14
	80	145	81	83,6		75	80				110x1/4"	1,50
	100	161	100	103,6		95	100				130x1/4"	2,40

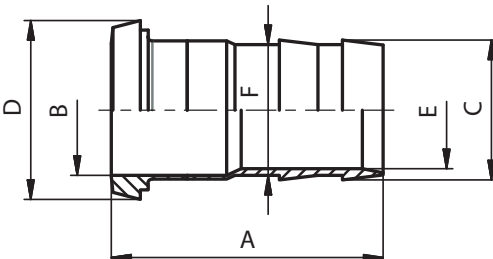
Liner hose fitting - K Schlauchstutzen - K	20520	Dimensions • Baumaße										
		DN	A	B	C	D	E	F	R	L	thread DIN 405 Rd x s	kg
	10	60	10	12	22,5	7	10					0,04
	15	61	16	18,5	28,5	13	15					0,06
	20	65	20	23	36,5	16	20					0,13
	25	70	26	28	44	20	25					0,19
	32	77	32	35,6	50	27	32					0,27
	40	88	38	43,6	56	35	40					0,42
	50	103	50	53,6	68,5	45	50					0,58
	65	125	66	66,6	86	58	65					1,08
	80	137	81	83,6	100	75	80					1,32
	100	151	100	103,6	121	95	100					2,13

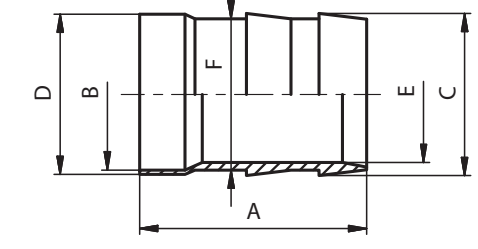
Liner hose fitting - S Schlauchstutzen - S	20530	Dimensions • Baumaße										
		DN	A	B	C	D	E	F	R	L	thread DIN 405 Rd x s	kg
	10	43	10	12	13	7	10					0,02
	15	44	16	18,5	19	13	15					0,04
	20	47	20	23	23	16	20					0,06
	25	48	26	28	29	20	25					0,06
	32	52	32	35,6	35	27	32					0,08
	40	62	38	43,6	41	35	40					0,12
	50	75	50	53,6	53	45	50					0,22
	65	93	66	66,6	70	58	65					0,58
	80	100	81	83,6	85	75	80					0,68
	100	107	100	103,6	104	95	100					1,72

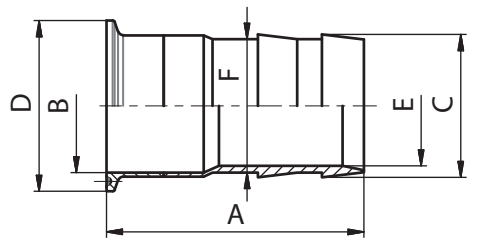
Liner hose fitting - C Schlauchstutzen - C	20540	Dimensions • Baumaße										
		DN	A	B	C	D	E	F	R	L	thread DIN 405 Rd x s	kg
	10	61	10	12	34	7	10					0,05
	15	62	16	18,5	34	13	15					0,08
	20	65	20	23	34	16	20					0,17
	25	69,5	26	28	50,5	20	25					0,23
	32	73,5	32	35,6	50,5	27	32					0,33
	40	83,5	38	43,6	50,5	35	40					0,52
	50	96,5	50	53,6	64	45	50					0,66
	65	121	66	66,6	91	58	65					1,14
	80	128	81	83,6	106	75	80					1,50
	100	135	100	103,6	119	95	100					2,40

Connecting clamp/clamp for hoses
Cupplungsstück C/C zu Schlauch

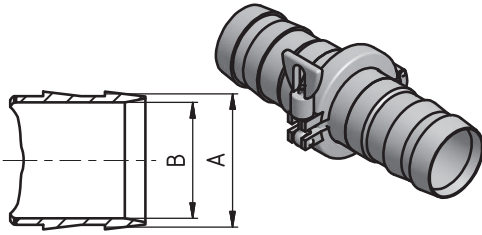
20549
Dimensions • Baumaße

DN	A	B	C	D	E	F	R	L	thread DIN 405 Rd x s	kg
10	12	7								0,30
15	18,5	13								0,32
20	23	16								0,36
25	28	20								0,41
32	35,6	27								0,43
40	43,6	35								0,49
50	53,6	45								0,61
65	66,6	58								1,47
80	83,6	75								1,63
100	103,6	95								2,71

Connecting piece G - G
Kupplungsstück G - G

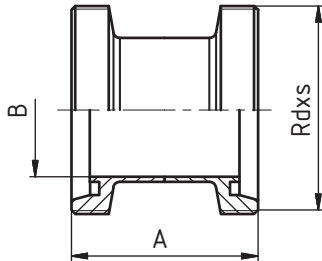
20570
Dimensions • Baumaße

DN	A	B	C	D	E	F	R	L	thread DIN 405 Rd x s	kg
10	42	10							28x1/8"	0,09
15	42	16							34x1/8"	0,11
20	48	20							44x1/6"	0,21
25	58	26							52x1/6"	0,28
32	64	32							58x1/6"	0,36
40	66	38							65x1/6"	0,46
50	70	50							78x1/6"	0,67
65	80	66							95x1/6"	1,06
80	90	81							110x1/4"	1,41
100	108	100							130x1/4"	2,13

Connecting piece K/M - G
Kupplungsstück K/M - G

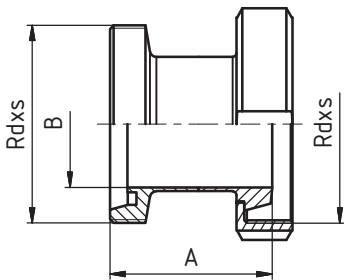
20580
Dimensions • Baumaße

DN	A	B	C	D	E	F	R	L	thread DIN 405 Rd x s	kg
10	42	10							28x1/8"	0,13
15	42	16							34x1/8"	0,16
20	48	20							44x1/6"	0,28
25	58	26							52x1/6"	0,39
32	64	32							58x1/6"	0,47
40	66	38							65x1/6"	0,55
50	70	50							78x1/6"	0,77
65	80	66							95x1/6"	1,24
80	90	81							110x1/4"	1,73
100	108	100							130x1/4"	2,40

Connecting piece K/M - K/M
Kupplungsstück K/M - K/M

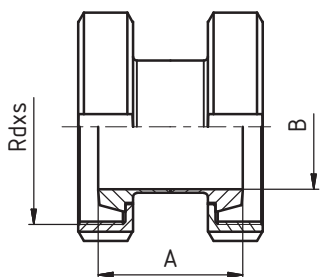
20590
Dimensions • Baumaße

DN	A	B	C	D	E	F	R	L	thread DIN 405 Rd x s	kg
10	34	10							28x1/8"	0,18
15	34	16							34x1/8"	0,22
20	36	20							44x1/6"	0,38
25	44	26							52x1/6"	0,54
32	50	32							58x1/6"	0,66
40	52	38							65x1/6"	0,76
50	56	50							78x1/6"	1,06
65	64	66							95x1/6"	1,72
80	74	81							110x1/4"	2,36
100	88	100							130x1/4"	3,38

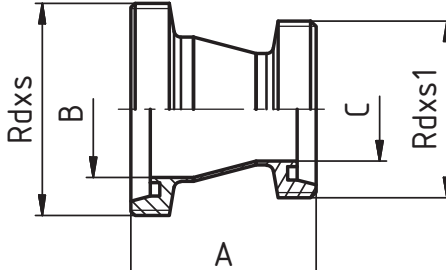
Recucing piece G - G Reduzierstück G - G	20630	Dimensions • Baumaße									
		DN	A	B	C	D	E	F	thread DIN 405 Rd x s	thread DIN 405 Rd x s1	kg
	32/25	55	32	26				58x1/6"	52x1/6"	0,36	
	40/25	66	38	25				65x1/6"	52x1/6"	0,40	
	40/32	55	38	32				65x1/6"	58x1/6"	0,46	
	50/32	78	50	32				78x1/6"	58x1/6"	0,61	
	50/40	68	50	38				78x1/6"	65x1/6"	0,67	
	65/40	98	66	38				95x1/6"	65x1/6"	1,00	
	65/50	77	66	50				95x1/6"	78x1/6"	1,06	
	80/50	104	81	50				110x1/4"	78x1/6"	1,37	
	80/65	77	81	66				110x1/4"	95x1/6"	1,41	
	100/65	116	100	66				130x1/4"	95x1/6"	2,08	
	100/80	89	100	81				130x1/4"	110x1/4"	2,13	

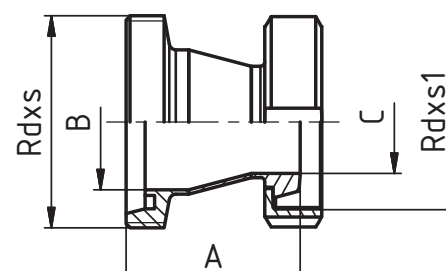
Recucing piece G - K/M Reduzierstück G - K/M	20640	Dimensions • Baumaße									
		DN	A	B	C	D	E	F	thread DIN 405 Rd x s	thread DIN 405 Rd x s1	kg
	32/25	51	32	26				58x1/6"	52x1/6"	0,47	
	40/25	62	38	26				65x1/6"	52x1/6"	0,50	
	40/32	59	38	32				65x1/6"	58x1/6"	0,55	
	50/32	74	50	32				78x1/6"	58x1/6"	0,71	
	50/40	64	50	38				78x1/6"	65x1/6"	0,77	
	65/40	94	66	38				95x1/6"	65x1/6"	1,19	
	65/50	73	66	50				95x1/6"	78x1/6"	1,24	
	80/50	100	81	50				110x1/4"	78x1/6"	1,68	
	80/65	73	81	66				110x1/4"	95x1/6"	1,73	
	100/65	112	100	66				130x1/4"	95x1/6"	2,35	
	100/80	85	100	81				130x1/4"	110x1/4"	2,40	

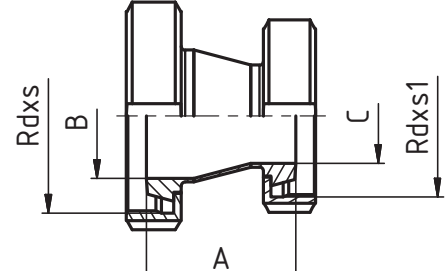
Recucing piece K/M - K/M Reduzierstück K/M - K/M	20650	Dimensions • Baumaße									
		DN	A	B	C	D	E	F	thread DIN 405 Rd x s	thread DIN 405 Rd x s1	kg
	32/25	47	32	26				58x1/6"	52x1/6"	0,66	
	40/25	58	38	26				65x1/6"	52x1/6"	0,71	
	40/32	47	38	32				65x1/6"	58x1/6"	0,76	
	50/32	70	50	32				78x1/6"	58x1/6"	1,01	
	50/40	60	50	38				78x1/6"	65x1/6"	1,06	
	65/40	90	66	38				95x1/6"	65x1/6"	1,67	
	65/50	69	66	50				95x1/6"	78x1/6"	1,72	
	80/50	96	81	50				110x1/4"	78x1/6"	2,30	
	80/65	69	81	66				110x1/4"	95x1/6"	2,36	
	100/65	107	100	66				130x1/4"	95x1/6"	3,32	
	100/80	80	100	81				130x1/4"	110x1/4"	3,38	

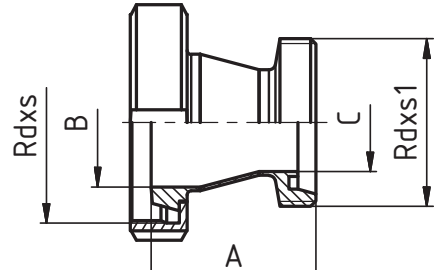
Recucing piece K/M - G Reduzierstück K/M - G	20660	Dimensions • Baumaße									
		DN	A	B	C	D	E	F	thread DIN 405 Rd x s	thread DIN 405 Rd x s1	kg
	32/25	51	32	26				58x1/6"	52x1/6"	0,47	
	40/25	62	38	25				65x1/6"	52x1/6"	0,50	
	40/32	59	38	32				65x1/6"	58x1/6"	0,55	
	50/32	74	50	32				78x1/6"	58x1/6"	0,71	
	50/40	64	50	38				78x1/6"	65x1/6"	0,77	
	65/40	94	66	38				95x1/6"	65x1/6"	1,19	
	65/50	73	66	50				95x1/6"	78x1/6"	1,24	
	80/50	100	81	50				110x1/4"	78x1/6"	1,68	
	80/65	73	81	66				110x1/4"	95x1/6"	1,73	
	100/65	112	100	66				130x1/4"	95x1/6"	2,35	
	100/80	85	100	81				130x1/4"	110x1/4"	2,40	

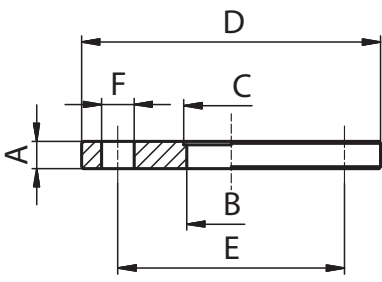
Flange PN 10 Flansch PN 10	20700	Dimensions • Baumaße										
	DIN 2576	DN	A	B	C	D	E	F	R	L	thread DIN 405 Rd x s	kg
	10	14	10	12,2	90	60	14x4					0,50
	15	14	16	18,2	95	65	14x4					0,60
	20	14	20	22,2	105	75	14x4					0,85
	25	14	26	28,2	115	85	14x4					1,11
	32	14	32	34,2	140	100	18x4					1,64
	40	14	38	40,2	150	110	18x4					1,80
	50	14	50	52,2	165	125	18x4					2,30
	65	14	66	70,3	185	145	18x4					2,88
	80	16	81	85,3	200	160	18x8					3,20
	100	16	100	104,3	220	180	18x8					4,00
	125	20	125	129,5	250	210	18x8					5,00
	150	24	150	154,5	285	240	22x8					6,70

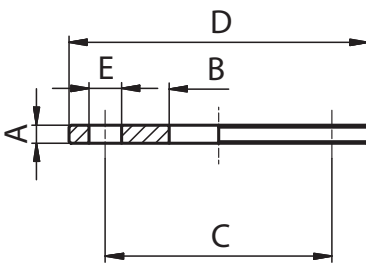
Flange PN 10 ECO Flansch PN 10 ECO	20700 ECO	Dimensions • Baumaße										
	DIN 2576	DN	A	B	C	D	E	F	R	L	thread DIN 405 Rd x s	kg
	25	10	29	85	115	14x4						0,69
	32	10	35	100	140	18x4						1,00
	40	10	41,5	110	150	18x4						1,16
	50	10	52,8	125	165	18x4						1,23
	65	10	71,2	145	185	18x4						1,68
	80	10	86,5	160	200	18x8						1,62
	100	10	105,5	180	220	18x8						1,89
	125	12	131	210	250	18x8						3,33
	150	12	155,5	240	285	22x8						4,12

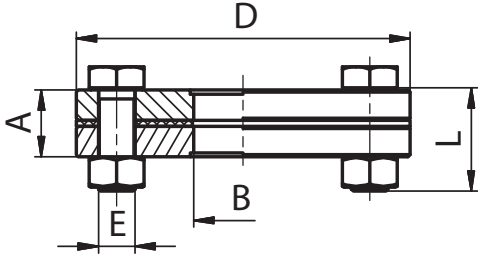
Flange connection PN 10 - complete Flanschverbindung PN 10 - komplett	20720	Dimensions • Baumaße										
	DIN 2576	DN	A	B	C	D	E	F	R	L	Rd x s	kg
	10	31	10		90	4 x M12				40		1,30
	15	31	16		95	4 x M12				40		1,40
	20	31	20		105	4 x M12				45		2,00
	25	31	26		115	4 x M12				45		2,30
	32	31	32		140	4 x M16				50		3,50
	40	31	38		150	4 x M16				50		4,00
	50	31	50		165	4 x M16				55		5,10
	65	32	66		185	4 x M16				55		6,00
	80	36	81		200	8 x M16				55		7,50
	100	36	100		220	8 x M16				55		8,30
	125	44	125		250	8 x M16				60		13,00
	150	52	150		285	8 x M20				65		16,70

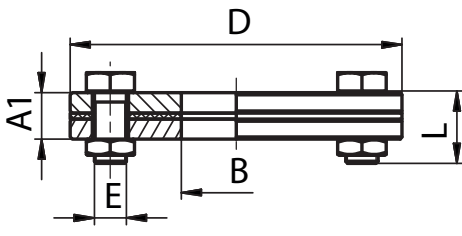
Flange connection PN 10 ECO - complete Flanschverbindung PN 10 ECO - komplett	20720 ECO	Dimensions • Baumaße										
	DIN 2576	DN	A1	B	C	D	E	F	R	L	thread DIN 405 Rd x s	kg
	10	23	17,7		90	4 x M12				35		1,20
	15	23	18,6		95	4 x M12				35		1,30
	20	23	26		105	4 x M12				35		1,60
	25	23	31		115	4 x M12				35		1,80
	32	23	39		140	4 x M16				40		2,80
	40	23	45,5		150	4 x M16				40		3,10
	50	23	54,5		165	4 x M16				40		3,80
	65	24	71		185	4 x M16				40		4,20
	80	24	85		200	8 x M16				40		4,80
	100	24	105,5		220	8 x M16				40		5,30
	125	28	130,5		250	8 x M16				45		8,30
	150	28	155,5		285	8 x M20				50		11,00

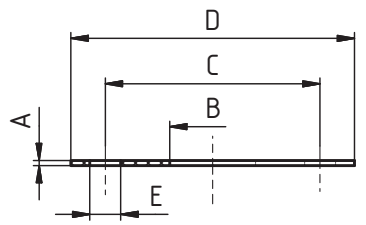
Flat seal for flange PN 10 Flanschdichtung PN 10	20710	Dimensions • Baumaße										
	DIN 2576	DN	A	B	C	D	E	F	R	L	thread DIN 405 Rd x s	kg
		10	3	10	60	90	14x4					
		15	3	16	65	95	14x4					
		20	3	20	75	105	14x4					
		25	3	26	85	115	14x4					
		32	3	32	100	140	18x4					
		40	3	38	110	150	18x4					
		50	3	50	125	165	18x4					
		65	4	66	145	185	18x4					
		80	4	81	160	200	18x8					
		100	4	100	180	220	18x8					
		125	4	125	210	250	18x8					
	150	4	150	240	285	22x8						

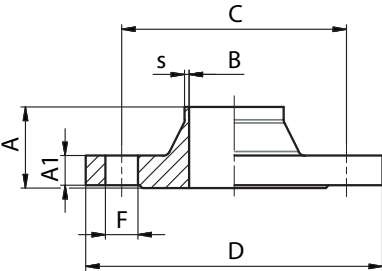
Flange PN 16 Flansch PN 16	20730	Dimensions • Baumaße									
	DIN 2633	DN	A	A1	B	C	D	F	s		kg
		10	35	14	10	60	90	14x4	1,5		0,58
		15	35	14	16	65	95	14x4	1,5		0,65
		20	38	16	20	75	105	14x4	1,5		0,95
		25	38	16	26	85	115	14x4	1,5		1,14
		32	40	16	32	100	140	18x4	1,5		1,60
		40	42	16	38	110	150	18x4	1,5		1,80
		50	45	18	50	125	165	18x4	1,5		2,53
		65	45	18	66	145	185	18x4	2		3,06
		80	50	20	81	160	200	18x8	2,5		3,70
		100	52	20	100	180	220	18x8	2,5		4,62
		125	55	22	125	210	250	18x8	2,5		6,30
	150	55	22	150	240	285	22x8	2,5		7,75	

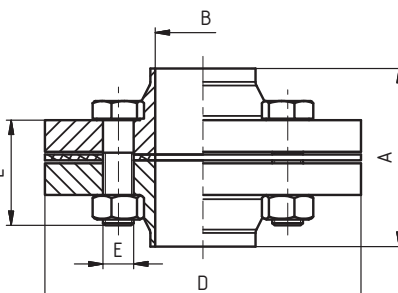
Flange connection PN 16 - complete Flanschverbindung PN 16 - komplett	20740	Dimensions • Baumaße										
	DIN 2633	DN	A	B	C	D	E	F	R	L	thread DIN 405 Rd x s	kg
		10	73	10		90	4 x M12			45		1,16
		15	73	16		95	4 x M12			45		1,30
		20	79	20		105	4 x M12			45		1,90
		25	79	26		115	4 x M12			50		2,28
		32	83	32		140	4 x M18			50		3,20
		40	88	38		150	4 x M18			50		3,60
		50	94	50		165	4 x M18			55		5,06
		65	94	66		185	4 x M18			55		6,12
		80	104	81		200	8 x M18			60		7,40
		100	108	100		220	8 x M18			60		9,24
		125	114	125		250	8 x M18			65		12,60
	150	114	150		285	8 x M22			70		15,5	

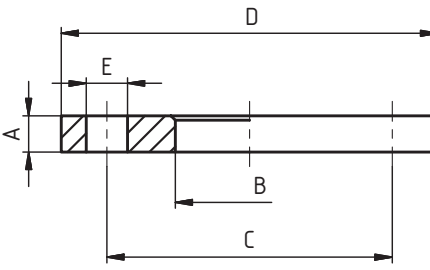
Flange AL Flansch AL	20780 AL	Dimensions • Baumaße										
		DN	A	B	C	D	E	F	R	L	thread DIN 405 Rd x s	kg
		10	14	19	60	90	14x4					0,59
		15	14	24	65	95	14x4					0,68
		20	16	24	75	105	14x4					0,80
		25	16	36	85	115	14x4					1,11
		32	16	46	100	140	18x4					1,64
		40	16	54	110	150	18x4					1,86
		50	16	65	125	165	18x4					2,20
		65	16	81	145	185	18x4					2,62
		80	18	94	160	200	18x8					3,32
		100	18	119	180	220	18x8					3,67
		125	18	145	210	250	18x8					4,54
		150	18	173	240	285	22x8					5,60

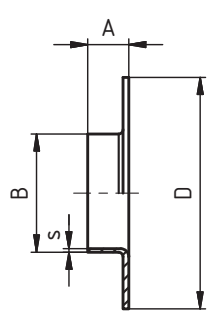
Welding neck DIN Vorschweissbördel DIN	20790	Dimensions • Baumaße										
	DIN	DN	A	B	C	D	E	F	R	s	thread DIN 405 Rd x s	kg
		10		12		40				1,5		
		15		18		45				1,5		
		20		23		58				1,5		
		25		28		68				1,5		
		32		35		78				1,5		
		40		40		88				1,5		
		50		52		102				1,5		
		65		70		122				2,0		
		80		85		138				2,0		
		100		104		158				2,0		
		125		129		188				2,0		
		150		154		212				2,0		

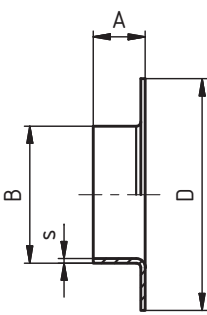
Welding neck ISO Vorschweissbördel ISO	20795	Dimensions • Baumaße										
	ISO	DN	A	B	C	D	E	F	R	s	thread DIN 405 Rd x s	kg
		10		17,2		40				2		
		15		21,3		45				2		
		20		26,9		58				2		
		25		33,7		68				2		
		32		42,4		78				2		
		40		48,3		88				2		
		50		60,3		102				2		
		65		76,1		122				2		
		80		88,9		138				3		
		100		114,3		158				3		
		125		139,7		188				3		
		150		168,3		212				3		

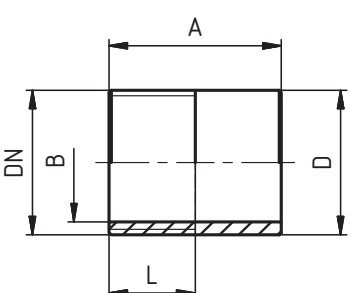
Nipple Nippel	20800	Dimensions • Baumaße										
		DN	A	B	C	D	E	F	R	L	thread DIN 405 Rd x s	kg
		1/8"	30	7		10,5				10		0,02
		1/4"	30	9,3		13,6				11		0,02
		3/8"	30	13		17,1				10,5		0,03
		1/2"	35	16		21,5				15,5		0,04
		3/4"	40	21,6		27				16,5		0,06
		1"	40	27,5		33,6				20		0,10
		1 1/4"	50	36,6		42,2				20		0,15
		1 1/2"	50	41,5		48,5				22,5		0,16
		2"	50	53,6		60,6				25,5		0,22
		2 1/2"	60	68,9		76,1				30		0,42
		3"	70	81,5		89,4				34		0,68
		4"	80	105,8		114,3				39		0,97

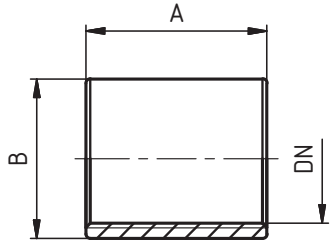
Muff Muffe	20840	Dimensions • Baumaße										
		DN	A	B	C	D	E	F	R	L	thread DIN 405 Rd x s	kg
		1/8"	15	15								0,02
		1/4"	25	18								0,02
		3/8"	26	20,5								0,03
		1/2"	33	25								0,08
		3/4"	35	32								0,11
		1"	42	37								0,17
		1 1/4"	45	46								0,32
		1 1/2"	45	52,5								0,40
		2"	55	65,5								0,48
		2 1/2"	63	81								1,20
	3"	69	95								1,57	
	4"	80	114,6								2,40	

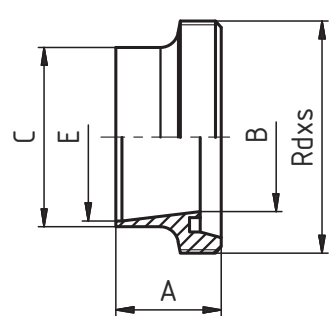
Welding male ISO Anschweißgewindestutzen ISO	21010	Dimensions • Baumaße										
	ISO	DN	A	B	C	D	E	F	R	L	thread DIN 405 Rd x s	kg
		10	21	10	18		14			4	28x1/8"	0,04
		15	21	16	21,3		18,1			4	34x1/8"	0,05
		20	24	20	26,9		23,7			6	44x1/6"	0,10
		25	29	26	33,7		29,7			7	52x1/6"	0,13
		32	32	32	42,4		38,4			7	58x1/6"	0,16
		40	33	38	48,3		44,3			7	65x1/6"	0,21
		50	35	50	60,3		56,3			7	78x1/6"	0,30
		65	40	66	76,1		71,5			8	95x1/6"	0,45
		80	45	81	88,9		84,3			8	110x1/4"	0,60
		100	54	100	114,3		109,1			10	130x1/4"	0,78

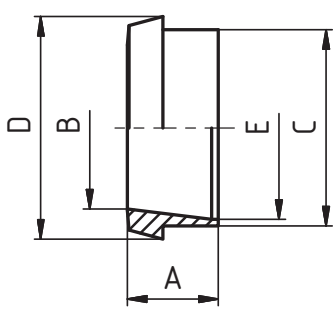
Welding liner ISO Anschweißkegelstutzen ISO	21020	Dimensions • Baumaße										
	ISO	DN	A	B	C	D	E	F	R	L	thread DIN 405 Rd x s	kg
		10	17	10	18	22,5	14					0,02
		15	17	16	21,3	28,5	18,1					0,03
		20	18	20	26,9	36,5	23,7					0,06
		25	22	26	33,7	44	29,7					0,09
		32	25	32	42,4	50	38,4					0,11
		40	26	38	48,3	56	44,3					0,14
		50	28	50	60,3	68,5	56,3					0,21
		65	32	66	76,1	86	71,5					0,32
		80	37	81	88,9	100	84,3					0,39
		100	44	100	114,3	121	109,1					0,59

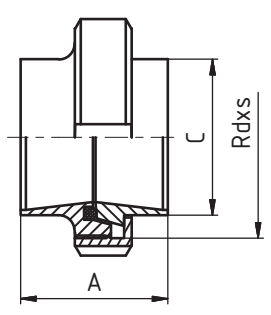
Welding union - complete ISO Anschweißverschraubung - komplett ISO	21030	Dimensions • Baumaße										
	ISO	DN	A	B	C	D	E	F	R	L	thread DIN 405 Rd x s	kg
		10	34		18						28x1/8"	0,15
		15	34		21,3						34x1/8"	0,18
		20	36		26,9						44x1/6"	0,30
		25	45		33,7						52x1/6"	0,42
		32	51		42,4						58x1/6"	0,51
		40	53		48,3						65x1/6"	0,61
		50	57		60,3						78x1/6"	0,84
		65	65		76,1						95x1/6"	1,31
		80	75		88,9						110x1/4"	1,80
		100	89		114,3						130x1/4"	2,66

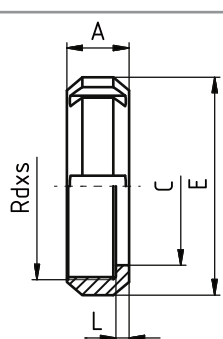
Nut SMS Nutmutter SMS	21080	Dimensions • Baumaße										
	SMS	DN	A	B	C	D	E	F	R	L	thread DIN 405 Rd x s	kg
	25	19		32		51				4	40 x 1/6"	0,11
	38	23		48		74				4	60 x 1/6"	0,26
	51	24		60,5		84				5	70 x 1/6"	0,31
	63,5	28		74		100				5	85 x 1/6"	0,41
	76	30		87		114				6	98 x 1/6"	0,57
	101,6	31		113		138				5	125 x 1/4"	1,20
	104	31		113		138				5	125 x 1/4"	1,22

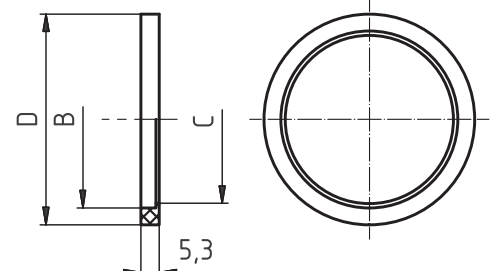
Gasket SMS Dichtung SMS	21090	Dimensions • Baumaße										
	SMS	DN	A	B	C	D	E	F	R	L	thread DIN 405 Rd x s	kg
	25		25,1	22,8	31,8							
	38		38,1	35,8	47,8							
	51		51,1	48,8	60,8							
	63,5		63,6	61	73,3							
	76		76,1	73,4	85,8							
	104		104	100,5	115,7							

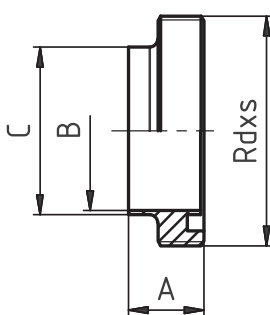
Welding male SMS Anschweißgewindestutzen SMS	21100	Dimensions • Baumaße										
	SMS	DN	A	B	C	D	E	F	R	L	thread DIN 405 Rd x s	kg
	25	19	22,5	25							40x1/6	0,05
	38	23	35,5	38							60x1/6	0,17
	51	23	48,5	51							70x1/6	0,18
	63,5	27	60,5	63,5							85x1/6	0,35
	76	27	72,9	76,1							98x1/6	0,44
	101,6	30	97,6	101,6							125x1/4	1,31
	104	30	100	104							125x1/4	1,32

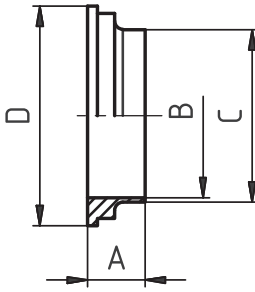
Welding liner SMS Anschweißkegelstutzen SMS	21110	Dimensions • Baumaße										
	SMS	DN	A	B	C	D	E	F	R	L	thread DIN 405 Rd x s	kg
	25	15,5	22,5	25	35,5							0,02
	38	16	35,5	38	55							0,04
	51	17	48,5	50,8	65							0,06
	63,5	17	60,5	63,5	80							0,08
	76	19	72,9	76,1	93							0,12
	101,6	19	97,6	101,6	118							0,27
	104	19	100	104	118							0,29

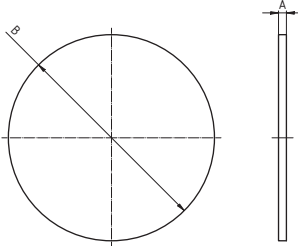
Gasket for SMS blind nuts Dichtung für SMS-Blindmuttern	21170	Dimensions • Baumaße										
	DIN 11 851	DN	A	B	C	D	E	F	R	L	thread DIN 405 Rd x s	kg
	25	3	39									
	38	3	58									
	51	3	68									
	63,5	3	84									
	76	3	97									
	101,6	3	125									
	104	3	130									

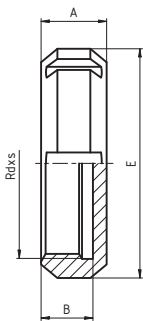
Blind nut SMS Blindmutter SMS	21180	Dimensions • Baumaße										
	DIN 11 851	DN	A	B	C	D	E	F	R	L	thread DIN 405 Rd x s	kg
	25	19	15				51				40x1/6	
	38	23	19				74				60x1/6	
	51	24	19				84				70x1/6	
	63,5	28	23				100				85x1/6	
	76	30	24				114				98x1/6	
	101,6	31	26				138				124x1/4	

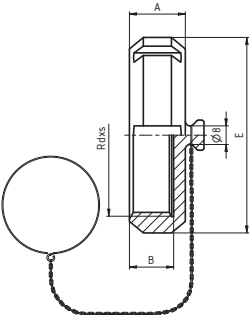
Blind nut SMS with chain Blindmutter SMS mit Kette	21190	Dimensions • Baumaße										
	DIN 11 851	DN	A	B	C	D	E	F	R	L	thread DIN 405 Rd x s	kg
	25	19	15				51				40x1/6	
	38	23	19				74				60x1/6	
	51	24	19				84				70x1/6	
	63,5	28	23				100				85x1/6	
	76	30	24				114				98x1/6	
	101,6	31	26				138				124x1/4	

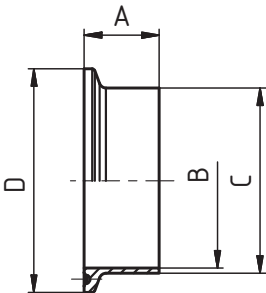
Clamp ferrule - S TC-Klemmstutzen - S	21200	Dimensions • Baumaße										
	DIN 32 676	DN	A	B	C	D	E	F	R	L	thread DIN 405 Rd x s	kg
	10	18	10	13	34							0,03
	15	18	16	19	34							0,03
	20	18	20	23	34							0,03
	25	21,5	26	29	50,5							0,07
	32	21,5	32	35	50,5							0,07
	40	21,5	38	41	50,5							0,07
	50	21,5	50	53	64							0,07
	65	28	66	70	91							0,10
	80	28	81	85	106							0,20
	100	28	100	104	119							0,22
	125	28	125	129	155							0,52
150	28	150	154	183							0,70	

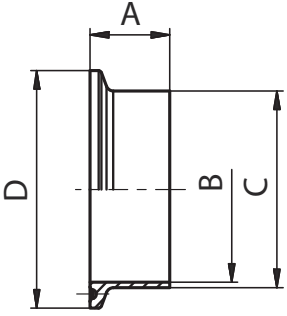
Clamp ferrule - S SMS TC-Klemmstutzen - S SMS	21202	Dimensions • Baumaße									
	SMS	DN - SMS	A	B	C	D	F	R	L	thread DIN 405 Rd x s	kg
		1/2" - 12,7	21,5	9,4	12,7	25					0,03
		3/4" - 19,05	21,5	15,75	19,05	25					0,03
		1" - 25,4	21,5	22,1	25,4	50,5					0,07
		1 1/2" - 38,1	28	35,5	38,1	50,5					0,07
		2" - 51	28	48,5	51	64					0,07
		2 1/2" - 63,5	28	60,5	63,5	77,5					0,1
		3" - 76,1	28	72,9	76,1	91					0,2
		4" - 101,6	28	97,6	101,6	119					0,22

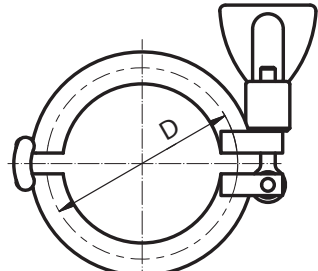
Clamp SMS TC-Klammer leichte Ausführung SMS	21220	Dimensions • Baumaße							
	DIN 32 676	DN	SMS	DIN	D	DN	SMS	DIN	D
		1/2"-3/4"	12,7	-	25	125	-	125	155
		1/2"-3/4"	19,05	-	25	6"	-	-	166,8
		10-20	-	10-20	34	150	-	150	183
		1"-1 1/2"	25	25	50,5	8"	-	-	217,6
		1"-1 1/2"	-	32	50,5	200	-	200	233,5
		1"-1 1/2"	38	40	50,5	250	-	250	268
		2"	51	50	64	300	-	300	318,5
		2 1/2"	63,5	-	77,5				
		3"	76,1	65	91				
		80	-	80	106				
		4"	101,6	100	119				

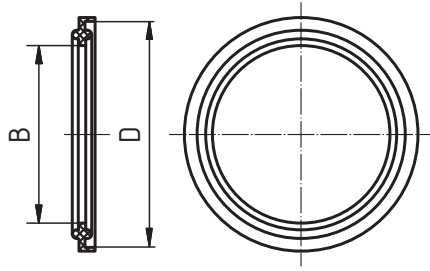
Clamp gasket Clamp Dichtung	21230	Dimensions • Baumaße										
	DIN 32 676	DN	A	B	C	D	E	F	R	L	thread DIN 405 Rd x s	kg
		10		10,2		34						
		15		16,2		34						
		20		20,2		34						
		25		26,2		50,5						
		32		32,2		50,5						
		40		38,2		50,5						
		50		50,2		64						
		65		66,2		91						
		80		81,2		106						
		100		100,2		119						

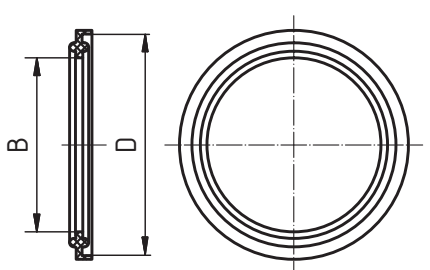
Clamp gasket SMS Clamp Dichtung SMS	21232	Dimensions • Baumaße									
	SMS	DN - SMS	B	D	E	F	R	L	thread DIN 405 Rd x s	kg	
		1/2" - 12,7	9,3	25							
		3/4" - 19,05	15,7	25							
		1" - 25	22,3	50,5							
		1 1/2" - 38,1	35	50,5							
		2" - 51	47,7	64							
		2 1/2" - 63,5	60,4	77,5							
		3" - 76,1	73,1	91							
		4" - 101,6	97,6	119							

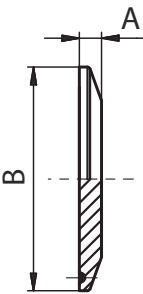
Clamp blank TC-Blindklemmstutzen	21240	Dimensions • Baumaße										
	DIN 32 676	DN	A	B	C	D	E	F	R	L	thread DIN 405 Rd x s	kg
		10	6,35	34								0,04
		15	6,35	34								0,04
		20	6,35	34								0,04
		25	6,35	50,5								0,08
		32	6,35	50,5								0,08
		40	6,35	50,5								0,08
		50	6,35	64								0,14
		65	6,35	91								0,28
		80	6,35	106								0,46
		100	7,95	119								0,60
		125	7,95	155								1,15
		150	11,00	183								2,20

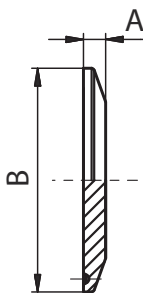
Clamp blank DIN/SMS TC-Blindklemmstutzen DIN/SMS	21242	Dimensions • Baumaße										
	SMS	DN - SMS	A	B	C	E	F	R	L	thread DIN 405 Rd x s	kg	
		1/2" - 12,7	6,35	25							0,04	
		3/4" - 19,05	6,35	25							0,04	
		1" - 25	6,35	50,5							0,08	
		1 1/2" - 38,1	6,35	50,5							0,08	
		2" - 51	6,35	64							0,14	
		2 1/2" - 63,5	6,35	77,5							0,28	
		3" - 76,1	6,35	91							0,46	
		4" - 101,6	7,95	119							0,6	

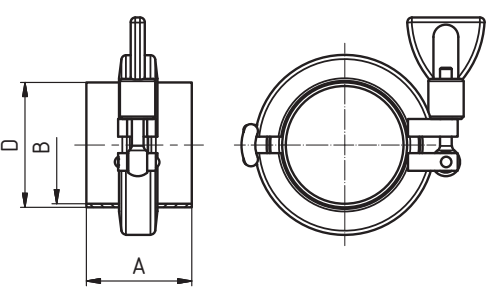
Clamp union - S - DIN - complete Clampverbindung - S - DIN - komplett	21250	Dimensions • Baumaße										
	DIN 32 676	DN	A	B	C	D	E	F	R	L	thread DIN 405 Rd x s	kg
		10	45	10		13						0,28
		15	45	16		19						0,28
		20	45	20		23						0,30
		25	45	26		29						0,35
		32	45	32		35						0,35
		40	45	38		41						0,37
		50	45	50		53						0,39
		65	58	66		70						0,89
		80	58	81		85						0,95
		100	58	100		104						0,99
		125	58	125		129						1,15
	150	58	150		154						1,30	

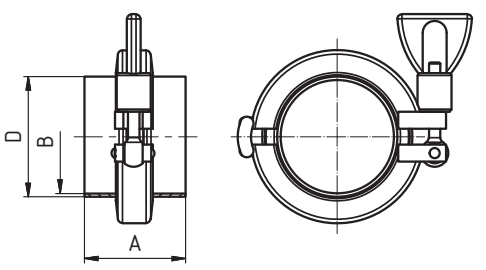
Clamp union - S - SMS - complete Clampverbindung - S - SMS - komplett	21252	Dimensions • Baumaße										
	SMS	DN	A	B	C	D	E	F	R	L	thread DIN 405 Rd x s	kg
		25	43	22,5		25						0,35
		38	43	35,5		38,1						0,37
		51	43	48,5		51						0,39
		63,5	56	60,5		63,5						0,89
		76	56	72,9		76,1						0,95
		101,6	56	97,6		101,6						0,99

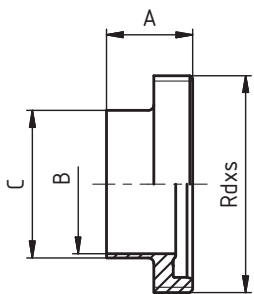
Welding male Anschweißgewindestutzen	22300	Welding union 22320, DIN 11 853-1									
	DIN 11 853	Anschweißerschraubung 22320, DIN 11 853-1									
	DN	A	B	C	D	E	F	R	L	závit DIN 405 Rd x s	kg
	10	19	10	13						28 x 1/8"	0,04
	15	19	16	19						34 x 1/8"	0,06
	20	21	20	23						44 x 1/6"	0,11
	25	26	26	29						52 x 1/6"	0,15
	32	30	32	35						58 x 1/6"	0,17
	40	31	38	41						65 x 1/6"	0,20
	50	31	50	53						78 x 1/6"	0,26
	65	36	66	70						95 x 1/6"	0,40
	80	42	81	85						110 x 1/4"	0,63
100	50	100	104						130 x 1/4"	0,76	

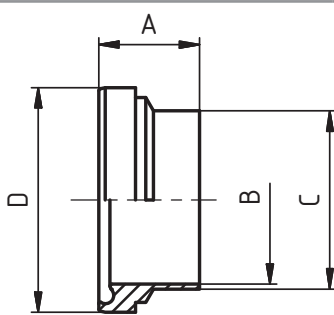
Welding liner Anschweißkegelstutzen	22310	Welding union 22320, DIN 11 853-1									
	DIN 11 853	Anschweißerschraubung 22320, DIN 11 853-1									
	DN	A	B	C	D	E	F	R	L	závit DIN 405 Rd x s	kg
	10	17	10	13	21,9						0,02
	15	17	16	19	27,9						0,03
	20	18	20	23	35,9						0,05
	25	22	26	29	42,9						0,08
	32	25	32	35	48,9						0,09
	40	26	38	41	54,9						0,11
	50	30	50	53	66,9						0,16
	65	34	66	70	84,9						0,30
	80	38	81	85	98,9						0,35
100	46	100	104	118,9						0,57	

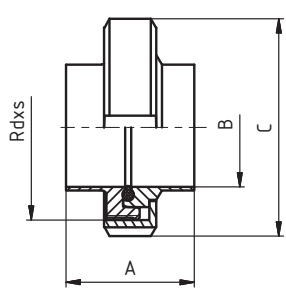
Welding union - complete Anschweißerschraubung - komplett	22320	Welding union 22320, DIN 11 853-1									
	DIN 11 853	Anschweißerschraubung 22320, DIN 11 853-1									
	DN	A	B	C	D	E	F	R	L	závit DIN 405 Rd x s	kg
	10	32	10	38						28 x 1/8"	0,14
	15	32	16	44						34 x 1/8"	0,18
	20	34	20	54						44 x 1/6"	0,30
	25	42	26	63						52 x 1/6"	0,41
	32	48	32	70						58 x 1/6"	0,48
	40	50	38	78						65 x 1/6"	0,57
	50	54	50	92						78 x 1/6"	0,78
	65	62	66	112						95 x 1/6"	1,27
	80	72	81	127						110 x 1/4"	1,76
100	86	100	148						130 x 1/4"	2,40	

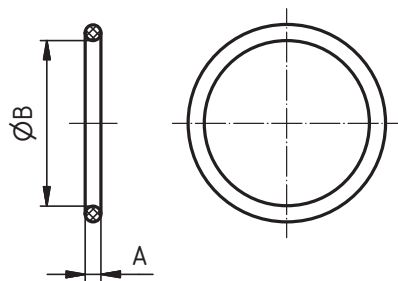
Gasket Dichtung	72020	Dimensions • Baumaße										
	DIN 11 853	DN	A	B	C	D	E	F	R	L	thread DIN 405 Rd x s	kg
	10	3,5	12									
	15	3,5	18									
	20	3,5	22									
	25	3,5	28									
	32	5	34									
	40	5	40									
	50	5	52									
	65	5	68									
	80	5	83									
	100	5	102									

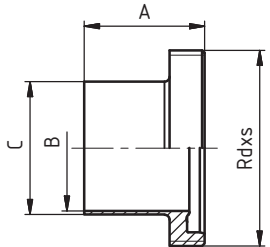
Welding male Anschweißgewindestutzen	22460	Welding union 22490, DIN 11 864-1									
	DIN 11 864-1-A	Anschweißerschraubung 22490, DIN 11 864-1									
	DN	A	B	C	D	E	F	R	L	thread DIN 405 Rd x s	kg
	10	41	10	13						28 x 1/8"	0,05
	15	41	16	19						34 x 1/8"	0,07
	20	43	20	23						44 x 1/6"	0,13
	25	43	26	29						52 x 1/6"	0,16
	32	48	32	35						58 x 1/6"	0,19
	40	48	38	41						65 x 1/6"	0,22
	50	48	50	53						78 x 1/6"	0,30
	65	60	66	70						95 x 1/6"	0,48
	80	64	81	85						110 x 1/4"	0,72
	100	64	100	104						130 x 1/4"	0,84

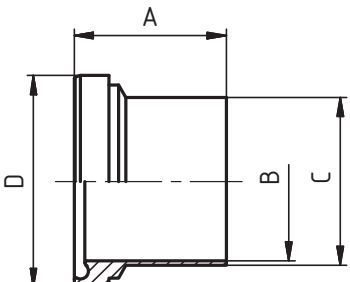
Welding liner Anschweißkegelstutzen	22470	Welding union 22490, DIN 11 864-1									
	DIN 11 864-1-A	Anschweißerschraubung 22490, DIN 11 864-1									
	DN	A	B	C	D	E	F	R	L	thread DIN 405 Rd x s	kg
	10	39	10	13	21,9						0,03
	15	39	16	19	27,9						0,04
	20	38	20	23	35,9						0,06
	25	40	26	29	42,9						0,10
	32	47	32	35	48,9						0,12
	40	47	38	41	54,9						0,14
	50	48	50	53	66,9						0,20
	65	61	66	70	84,9						0,38
	80	61	81	85	98,9						0,44
	100	66	100	104	118,9						0,67

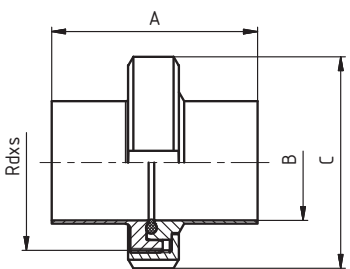
Welding union - complete Anschweißerschraubung - komplett	22490	Welding union 22490, DIN 11 864-1									
	DIN 11 864-1-A	Anschweißerschraubung 22490, DIN 11 864-1									
	DN	A	B	C	D	E	F	R	L	thread DIN 405 Rd x s	kg
	10	76	10	38						28x1/8"	0,08
	15	76	16	44						34x1/8"	0,11
	20	76	20	54						44x1/6"	0,19
	25	77	26	63						52x1/6"	0,26
	32	88	32	70						58x1/6"	0,31
	40	88	38	78						65x1/6"	0,36
	50	89	50	92						78x1/6"	0,50
	65	113	66	112						95x1/6"	0,86
	80	117	81	127						110x1/4"	1,16
	100	120	100	148						130x1/4"	1,51

Hygienic flange "BF" Hygiene Bundflansch "BF"	22850 (BF)	Hygienic flange connection PN10 DIN 11853 Hygiene flanschverbindung PN 10 DIN 11853
	DIN 11 853	

DN	A	B	C	D	E	F	R	L	závit DIN 405 Rd x s	kg
10	24	10	54	37	9x4	13		10		0,16
15	24	16	59	42	9x4	19		10		0,18
20	24	20	64	47	9x4	23		10		0,21
25	24	26	70	53	9x4	29		10		0,25
32	24	32	76	59	9x4	35		10		0,28
40	24	38	82	65	9x4	41		10		0,32
50	24	50	94	77	9x4	53		10		0,39
65	24	66	113	95	9x8	70		10		0,52
80	26	81	133	112	11x8	85		12		0,80
100	26	100	159	137	11x8	104		14		1,29
125	28	125	183	161	11x8	129		14		1,54
150	28	150	213	188	14x8	154		16		2,19

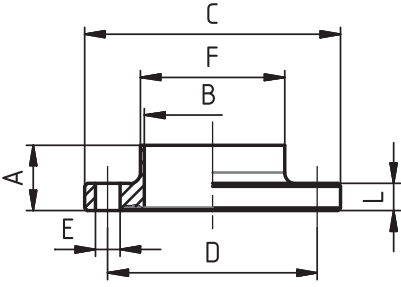

Hygienic flange "NF" Hygiene Bundflansch "NF"	22860 (NF)	Hygienic flange connection PN10 DIN 11853 Hygiene flanschverbindung PN 10 DIN 11853
	DIN 11 853	

DN	A	B	C	D	E	F	R	L	závit DIN 405 Rd x s	kg
10	25,5	10	54	37	9x4	13		11,5		0,16
15	25,5	16	59	42	9x4	19		11,5		0,18
20	25,5	20	64	47	9x4	23		11,5		0,21
25	25,5	26	70	53	9x4	29		11,5		0,25
32	25,5	32	76	59	9x4	35		11,5		0,28
40	25,5	38	82	65	9x4	41		11,5		0,32
50	25,5	50	94	77	9x4	53		11,5		0,39
65	25,5	66	113	95	9x8	70		11,5		0,52
80	27,5	81	133	112	11x8	85		13,5		0,80
100	27,5	100	159	137	11x8	104		15,5		1,29
125	29,5	125	183	161	11x8	129		15,5		1,54
150	29,5	150	213	188	14x8	154		17,5		2,19

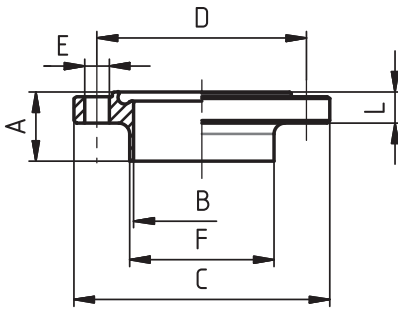

Hygienic flange connection PN10 - complete Hygiene flanschverbindung PN 10 - komplett	22870	Hygienic flange connection PN10 DIN 11853 Hygiene flanschverbindung PN 10 DIN 11853
	DIN 11 853	

DN	A	B	C	D	E	F	R	L	závit DIN 405 Rd x s	kg
10	48	10	54		4 x M8			28		0,41
15	48	16	59		4 x M8			28		0,46
20	48	20	64		4 x M8			28		0,52
25	48	26	70		4 x M8			28		0,60
32	48	32	76		4 x M8			28		0,66
40	48	38	82		4 x M8			28		0,73
50	48	50	94		4 x M8			28		0,87
65	48	66	113		8 x M8			28		1,21
80	52	81	133		8 x M10			35		1,96
100	52	100	159		8 x M10			40		2,97
125	56	125	183		8 x M10			40		3,47
150	56	150	213		8 x M12			45		5,02

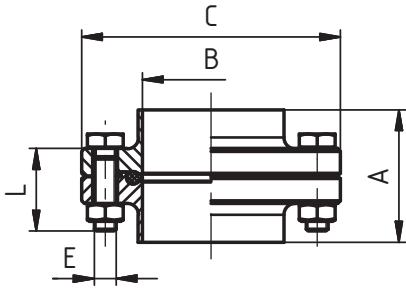

Welding aseptic flange "NF" Aseptic Bundflansch "NF"	22910 (BF)	Aseptic flange connection PN 10 DIN 11864
	DIN 11 864-2-A	Aseptic flanschverbindung PN 10 DIN 11864

DN	A	B	C	D	E	F	R	L	závit DIN 405 Rd x s	kg
10	40	10	54	37	9x4	13		10		0,16
15	40	16	59	42	9x4	19		10		0,18
20	40	20	64	47	9x4	23		10		0,21
25	40	26	70	53	9x4	29		10		0,25
32	45	32	76	59	9x4	35		10		0,28
40	45	38	82	65	9x4	41		10		0,32
50	45	50	94	77	9x4	53		10		0,39
65	54	66	113	95	9x8	70		10		0,52
80	58	81	133	112	11x8	85		12		0,80
100	58	100	159	137	11x8	104		14		1,29
125	60	125	183	161	11x8	129		14		1,54
150	60	150	213	188	14x8	154		16		2,19

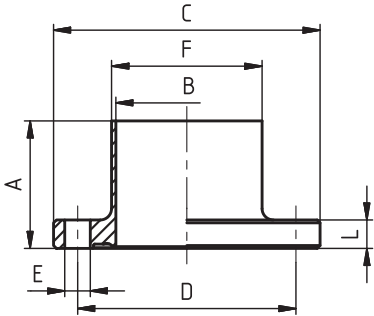

Welding aseptic neck "NF" Aseptic Bundflansch "NF"	22920 (NF)	Aseptic flange connection PN 10 DIN 11864
	DIN 11 864-2-A	Aseptic flanschverbindung PN 10 DIN 11864

DN	A	B	C	D	E	F	R	L	závit DIN 405 Rd x s	kg
10	41,5	10	54	37	9x4	13		11,5		0,16
15	41,5	16	59	42	9x4	19		11,5		0,18
20	41,5	20	64	47	9x4	23		11,5		0,21
25	41,5	26	70	53	9x4	29		11,5		0,25
32	46,5	32	76	59	9x4	35		11,5		0,28
40	46,5	38	82	65	9x4	41		11,5		0,32
50	46,5	50	94	77	9x4	53		11,5		0,39
65	55,5	66	113	95	9x8	70		11,5		0,52
80	59,5	81	133	112	11x8	85		13,5		0,80
100	59,5	100	159	137	11x8	104		15,5		1,29
125	61,5	125	183	161	11x8	129		15,5		1,54
150	61,5	150	213	188	14x8	154		17,5		2,19

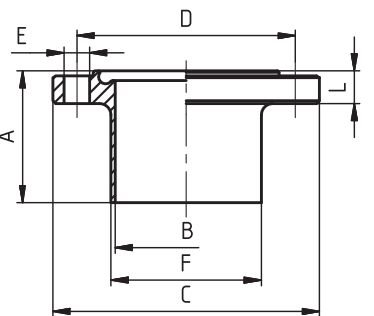

Aseptic flange connection PN10 - complete Aseptic flanschverbindung PN 10 - komplett	22930	Aseptic flange connection PN 10 DIN 11864
	DIN 11 864-2-A	Aseptic flanschverbindung PN 10 DIN 11864

DN	A	B	C	D	E	F	R	L	závit DIN 405 Rd x s	kg
10	80	10	54		4 x M8			28		
15	80	16	59		4 x M8			28		
20	80	20	64		4 x M8			28		
25	80	26	70		4 x M8			28		
32	90	32	76		4 x M8			28		
40	90	38	82		4 x M8			28		
50	90	50	94		4 x M8			28		
65	108	66	113		8 x M8			28		
80	116	81	133		8 x M10			35		
100	116	100	159		8 x M10			40		
125	120	125	183		8 x M10			40		
150	120	150	213		8 x M12			45		

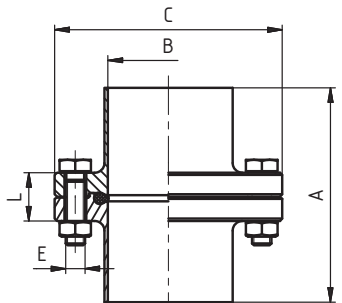

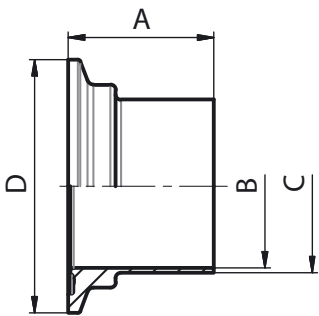
Clamp ferrule S (BKS) Klampsutzen S (BKS)	22950 (BKS)	Clamp union - S - DIN 11864-3									
	DIN 11864-3	Clampverbindung - S - DIN 11864-3									
	DN	A	B	C	D	E	F	R	L	thread DIN 405 Rd x s	kg
	10	38	10	13	34						
	15	38	16	19	34						
	20	38	20	23	50,5						
	25	38,5	26	29	50,5						
	32	44	32	35	50,5						
	40	44	38	41	64						
	50	44,5	50	53	77,5						
	65	56,5	66	70	91						
	80	58,5	81	85	106						
	100	60	100	104	130						

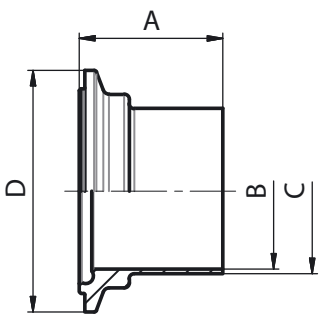
Clamp ferrule S (NKS) Klampsutzen S (NKS)	22960 (NKS)	Clamp union - S - DIN 11864-3									
	DIN 11864-3	Clampverbindung - S - DIN 11864-3									
	DN	A	B	C	D	E	F	R	L	thread DIN 405 Rd x s	kg
	10	39,5	10	13	34						
	15	39,5	16	19	34						
	20	39,5	20	23	50,5						
	25	40	26	29	50,5						
	32	45,5	32	35	50,5						
	40	45,5	38	41	64						
	50	46	50	53	77,5						
	65	58	66	70	91						
	80	60	81	85	106						
	100	61,5	100	104	130						

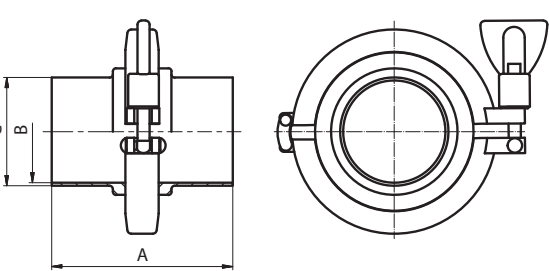
Clamp union S DIN 11864-3 - complete Clampverbindungen S DIN 11864-3 - komplett	22970	Clamp union - S - DIN 11864-3									
	DIN 11864-3	Clampverbindung - S - DIN 11864-3									
	DN	A	B	C	D	E	F	R	L	thread DIN 405 Rd x s	kg
	10	77,5	10	13							
	15	77,5	16	19							
	20	77,5	20	23							
	25	78,5	26	29							
	32	89,5	32	35							
	40	89,5	38	41							
	50	90,5	50	53							
	65	114,5	66	70							
	80	118,5	81	85							
	100	121,5	100	104							

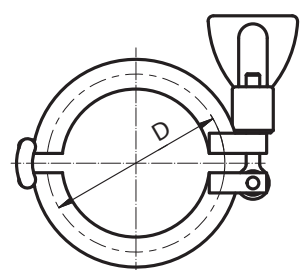
Clamp TC-Klammer leichte Ausführung	21220	Dimensions • Baumaße									
		DN	SMS	DIN	D	DIN 11864-3	R	L	závit DIN 405 Rd x s	kg	
	10-20	-	10-20	34	10-15						
	1"-1 1/2"	25	25	50,5	20						
	1"-1 1/2"	-	32	50,5	25						
	1"-1 1/2"	38	40	50,5	32						
	2"	51	50	64	40						
	2 1/2"	63,5	-	77,5	50						
	3"	76,1	65	91	65						
	80	-	80	106	80						
	115	-	-	130	100						

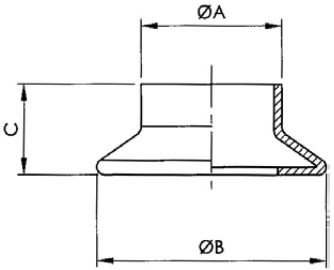
Long welding garolla fitting Anschw. Garollastutzen zoll	23400	Dimensions • Baumaße										
		DN	A	B	C	D	E	F	R	L	thread DIN 405 Rd x s	kg
		40	41	65	31							0,12
		50	46	76	34							0,20
		60	58	87	35							0,20
		70	73	97	35							0,24
		80	86	108	36							0,28
		100	101	129	40							
		120	124	158	46							

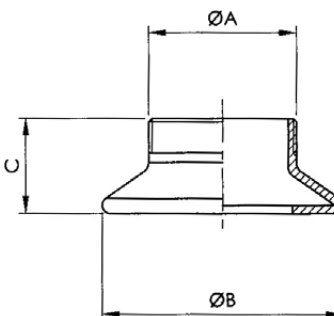
Half garolla fitting BSP ext. thread Garollastutzen mit ISO außengewinde	23440	Dimensions • Baumaße										
		DN	A	B	C	D	E	F	R	L	thread DIN 405 Rd x s	kg
		40	1¼" G	65	31							
		50	1½" G	76	34							
		60	2" G	87	35							
		70	2½" G	97	35							
		80	3" G	108	36							
		100	4" G	129	40							
		120	5" G	158	46							

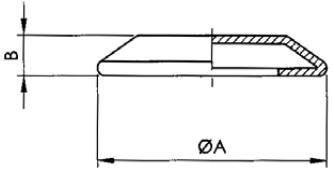
Garolla cap Klemmstöpsel	23480	Dimensions • Baumaße										
		DN	A	B	C	D	E	F	R	L	thread DIN 405 Rd x s	kg
		40	65	19								0,10
		50	76	19								0,14
		60	87	19								
		70	97	19								
		80	108	19								
		100	129	20								0,38
		120	158	25								

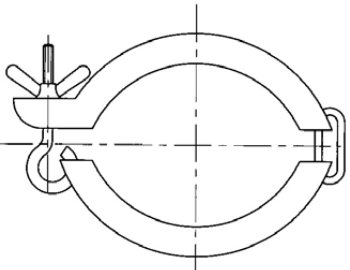
Clamp for connectors Klemmen für anschluss	23520	Dimensions • Baumaße										
		DN	A	B	C	D	E	F	R	SW	thread DIN 405 Rd x s	kg
		40										0,26
		50										0,28
		60										0,28
		70										0,30
		80										0,36
		100										0,40
		120										

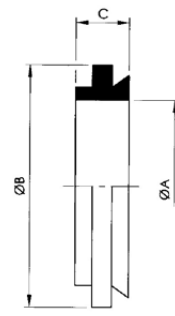
Winery sealing ring Dichtung	2352 B	Dimensions • Baumaße										
		DN	A	B	C	D	E	F	R	SW	thread DIN 405 Rd x s	kg
		40	40	62								0,018
		50	50	72								0,018
		60	60	82								0,028
		70	70	94								0,040
		80	80	104								0,040
		100	100	124								
		120	120	154								

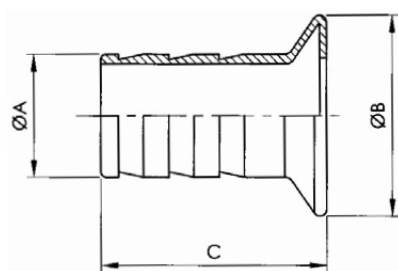
Garolla hose holder Halber Klemmaschluss	23600	Dimensions • Baumaße										
		DN	A	B	C	D	E	F	R	L	thread DIN 405 Rd x s	kg
		40	40	65	80							0,22
		50	50	76	90							0,32
		60	60	87	95							
		70	70	97	100							0,44
		80	80	108	120							0,54
		100	100	129	140							
		120	120	158	150							

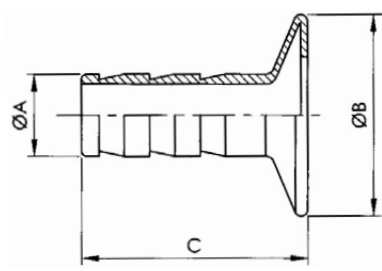
Garolla hose holder for reduction Reduziert schlauchgarollastutzen	23640	Dimensions • Baumaße									
		DN	A	B	C	L	thread DIN 405 Rd x s	kg			
		40	40 x 20, 40 x 25, 40 x 30, 40 x 35	65	80						
		50	50 x 20, 50 x 25, 50 x 30, 50 x 35	76	90						
		60	60 x 30, 60 x 35, 60 x 40, 60 x 50	87	95						
		70	70 x 35, 70 x 40, 70 x 50, 70 x 60	97	100						
		80	80 x 40, 80 x 50, 80 x 60, 80 x 70	108	120						
		100	100 x 50, 100 x 60, 100 x 70, 100 x 80	129	140						
		120	120 x 80, 120 x 100	158	150						

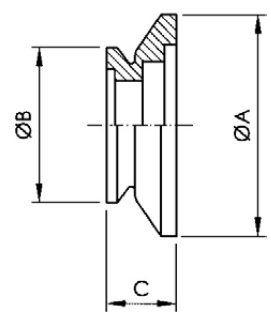
Garolla reduction Garolla-reduzierstück	23680	Dimensions • Baumaße									
		DN	A	B	C	D	E	F	R	L	thread DIN 405 Rd x s
		50/40	76	65	55						
		60/50	87	76	60						
		70/50	98	76	62						
		70/60	98	87	64						
		80/70	108	98	68						
		100/70	129	98	70						
		100/80	129	108	75						
	120/100	158	129	85							

Expanding union
Einwalzverschraubung

20090

Description
Beschreibung

DIN 11 851



Expanding union 20090, DIN 11 851

- Simple instalation
- Easy gasket exchange

Einwalzverschraubung 20090, DIN 11 851

- Einfache die Dichtung austauschen
- Einfache Installation

Dimensions/Baumaße: DN 10 - DN 150

Thread / Gewinde: DIN 405

Material / Material: 1.4301 (AISI 304)
1.4404 (AISI 316L)

Gasket / Dichtung: NBR
EPDM
Viton
Silikon
PTFE

Komponents / Komponenten

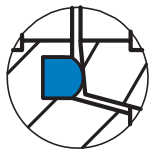

Detail gasket
Detail der Dichtung

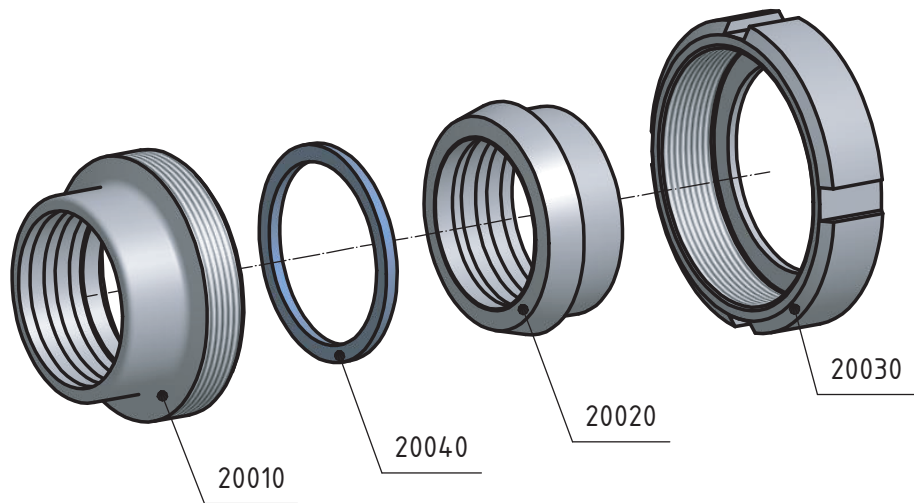

Standard gasket / Standard dichtung - NBR

Expanding union - complete
Einwalzverschraubung - komplett

20090

Dimensions • Baumaße

DIN 11 851

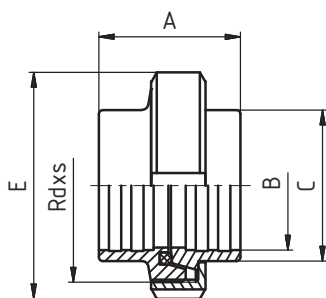

DN	A	B	C	D	E	F	R	L	thread DIN 405 Rd x s	kg
25	45	28,2	35		63				52x1/6"	0,16
32	51	34,2	41		70				58x1/6"	0,19
40	53	40,3	48		78				65x1/6"	0,24
50	57	52,3	61		92				78x1/6"	0,34
65	65	70,4	79		112				95x1/6"	0,51
80	75	85,4	93		127				110x1/4"	0,72

Welding union
Anschweißverschraubung

20120

Description
Beschreibung

DIN 11 851



Expanding union 20120, DIN 11 851

- Simple instalation
- Easy gasket exchange

Einwalverschraubung 20120, DIN 11 851

- Einfache die Dichtung austauschen
- Einfache Installation

Dimensions/Baumaße: DN 10 - DN 150

Thread / Gewinde: DIN 405

Material / Material: 1.4301 (AISI 304)
1.4404 (AISI 316L)

Gasket / Dichtung: NBR
EPDM
Viton
Silikon
PTFE

Komponents / Komponenten

Strength of the walls / Stärke der Mauern

DN 10	1,5 mm
DN 15 - 50	2,5 mm
DN 65 - 100	3,0 mm
DN 125 - 150	3,5 mm

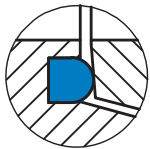

Detail gasket
Detail der Dichtung

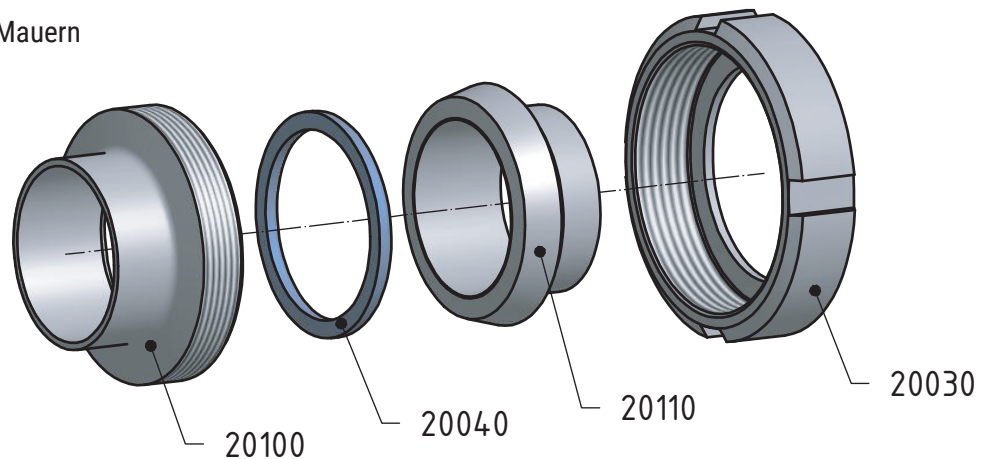

Standard gasket / Standard dichtung - NBR

Welding union - complete
Anschweißverschraubung - komplett

20120

Dimensions • Baumaße

DIN 11 851

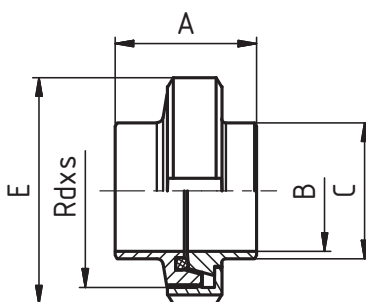

DN	A	B	C	D	E	F	R	L	thread DIN 405 Rd x s	kg
10	35	10	15		38				28 x 1/8"	0,17
15	35	16	21		44				34 x 1/8"	0,18
20	37	20	25		54				44 x 1/6"	0,32
25	45	26	31		63				52 x 1/6"	0,40
32	51	32	37		70				58 x 1/6"	0,49
40	53	38	43		78				65 x 1/6"	0,58
50	57	50	55		92				78 x 1/6"	0,84
65	65	66	72		112				95 x 1/6"	1,15
80	75	81	87		127				110 x 1/4"	1,74
100	89	100	106		148				130 x 1/4"	2,46
125	69	125	132		178				160 x 1/4"	3,52
150	74	150	157		210				190 x 1/4"	4,74

Welding union - Type "R"
Anschweißverschraubung - Typ "R"

20120 R

Description
Beschreibung

DIN 11 851



Welding union 20120 - R, DIN 11 851

- Simple instalation
- Easy gasket exchange

Anschweißverschraubung 20120 - R, DIN 11 851

- Einfache die Dichtung austauschen
- Einfache Installation

Dimensions/Baumaße: DN 10 - DN 150

Thread / Gewinde: DIN 405

Material / Material: 1.4301 (AISI 304)
1.4404 (AISI 316L)

Gasket / Dichtung: NBR
EPDM
Viton
Silikon
PTFE

Komponents / Komponenten

Strength of the walls / Stärke der Mauern

DN 10 - 50 1,5 mm

DN 50 - 150 2,0 mm

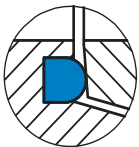

Detail gasket
Detail der Dichtung

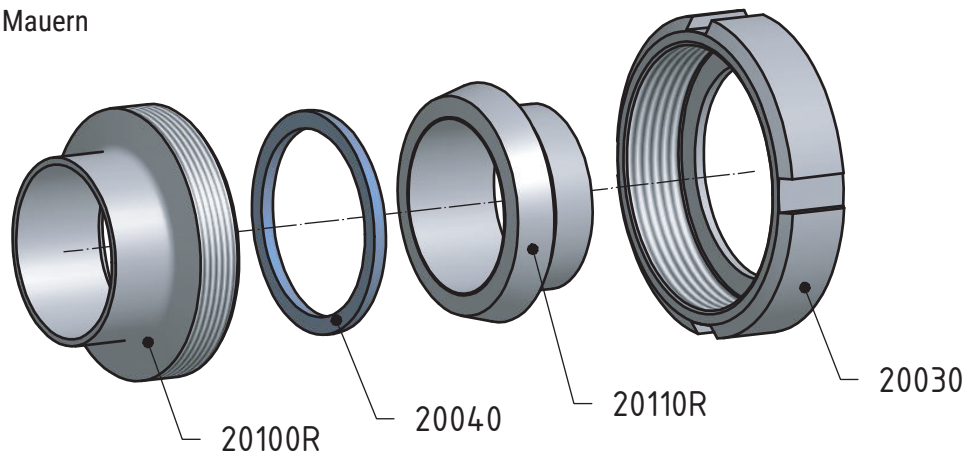

Standard gasket / Standard dichtung - NBR

Welding union - complete
Anschweißverschraubung - komplett

20120 R

Dimensions • Baumaße

DIN 11 851

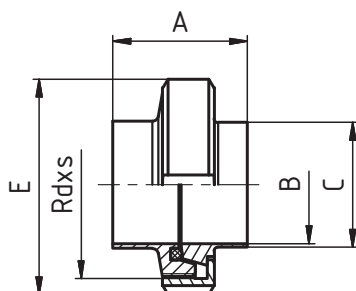

DN	A	B	C	D	E	F	R	L	thread DIN 405 Rd x s	kg
10	35	10	13		38				28 x 1/8"	0,13
15	35	16	19		44				34 x 1/4"	0,16
20	37	20	23		54				44 x 1/6"	0,28
25	45	26	29		63				52 x 1/6"	0,37
32	51	32	35		70				58 x 1/6"	0,45
40	53	38	41		78				65 x 1/6"	0,53
50	57	50	53		92				78 x 1/6"	0,67
65	65	66	70		112				95 x 1/6"	1,19
80	75	81	85		127				110 x 1/4"	1,67
100	89	100	104		148				130 x 1/4"	2,32
125	69	125	129		178				160 x 1/4"	3,21
150	74	150	154		210				190 x 1/4"	4,60

Welding union - Type "T"
Anschweißverschraubung - Typ "T"

20120 T

Description
Beschreibung



Welding union 20120 - T, DIN 11 851

- Simple installation
- Easy gasket exchange

Anschweißverschraubung 20120 - T, DIN 11 851

- Einfache die Dichtung austauschen
- Einfache Installation

Dimensions/Baumaße: DN 10 - DN 150

Thread / Gewinde: DIN 405

Material / Material: 1.4301 (AISI 304)
1.4404 (AISI 316L)

Gasket / Dichtung: NBR
EPDM
Viton
Silikon
PTFE

Komponents / Komponenten

Strength of the walls / Stärke der Mauern

DN 10 - 15	4,0 mm
DN 20	5,0 mm
DN 25 - 32	4,5 mm
DN 40	5,0 mm
DN 50	5,5 mm
DN 65	6,5 mm
DN 80	6,0 mm
DN 100	7,0 mm

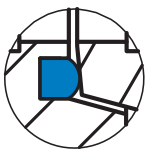

Detail gasket
Detail der Dichtung

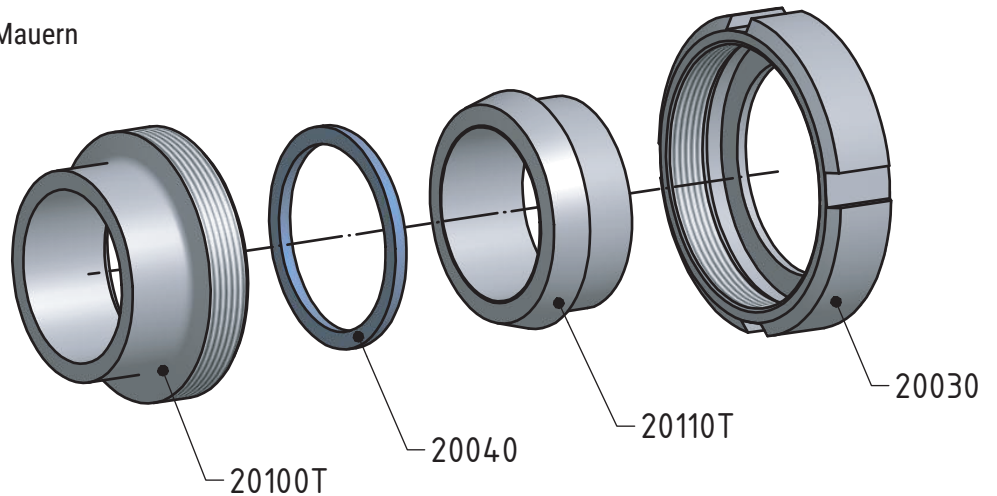

Standard gasket / Standard dichtung - NBR

Welding union - complete
Anschweißverschraubung - komplett

20120 T

Dimensions • Baumaße

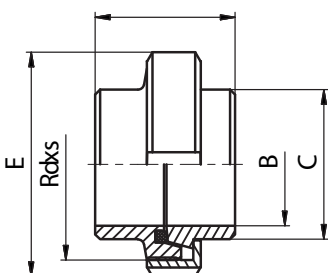

DN	A	B	C	D	E	F	R	L	thread DIN 405 Rd x s	kg
10	35	10	18		38				28x1/8"	0,19
15	35	16	24		44				34x1/4"	0,19
20	37	20	30		54				44x1/6"	0,34
25	45	26	35		63				52x1/6"	0,45
32	51	32	41		70				58x1/6"	0,57
40	53	38	48		78				65x1/6"	0,69
50	57	50	61		92				78x1/6"	0,96
65	65	66	79		112				95x1/6"	1,58
80	75	81	93		127				110x1/4"	2,20
100	89	100	114		148				130x1/4"	3,12

Welding union ISO Anschweißverschraubung ISO	21030	Description Beschreibung
	ISO	
		<p>Welding union 21030 ISO</p> <ul style="list-style-type: none"> - Simple instalation - Easy gasket exchange <p>Anschweißverschraubung 21030 ISO</p> <ul style="list-style-type: none"> - Einfache die Dichtung austauschen - Einfache Installation <p>Dimensions/Baumaße: DN 10 - DN 150</p> <p>Thread / Gewinde: DIN 405</p> <p>Material / Material: 1.4301 (AISI 304) 1.4404 (AISI 316L)</p> <p>Gasket / Dichtung: NBR EPDM Viton Silikon PTFE</p>

Komponents / Komponenten

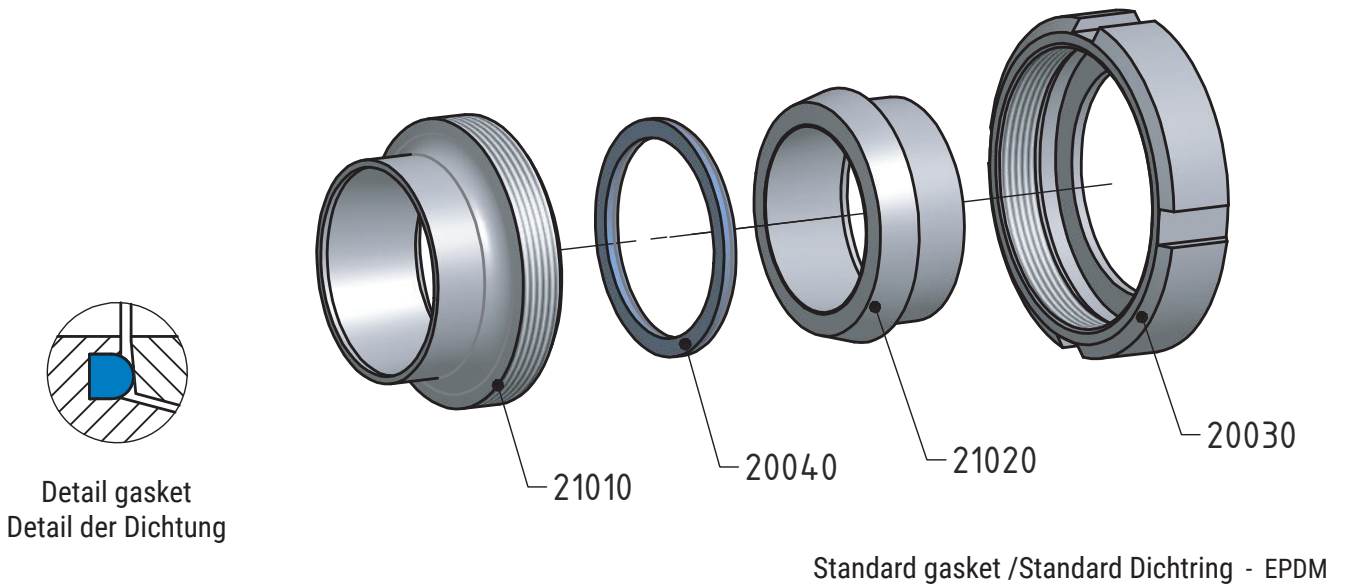

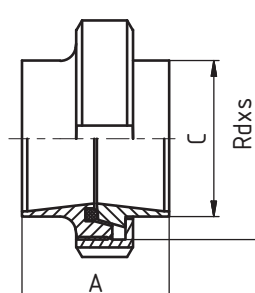
Welding union - complete ISO Anschweißverschraubung - komplett ISO	21030	Dimensions • Baumaße										
	ISO	DN	A	B	C	D	E	F	R	L	thread DIN 405 Rd x s	kg
		10	34		18						28x1/8"	0,15
		15	34		21,3						34x1/8"	0,18
		20	36		26,9						44x1/6"	0,30
		25	45		33,7						52x1/6"	0,42
		32	51		42,4						58x1/6"	0,51
		40	53		48,3						65x1/6"	0,61
		50	57		60,3						78x1/6"	0,84
		65	65		76,1						95x1/6"	1,31
		80	75		88,9						110x1/4"	1,80
		100	89		114,3						130x1/4"	2,66

Welding union SMS
Anschweißverschraubung SMS

21120

Description
Beschreibung

SMS



Welding union SMS 21120

- Simple instalation
- Easy gasket exchange

Anschweißverschraubung SMS 21120

- Einfache die Dichtung austauschen
- Einfache Installation

Dimensions / Baumaße: DN 10 - DN 150

Thread / Gewinde: DIN 405

Material / Material: 1.4301 (AISI 304)
1.4404 (AISI 316L)

Gasket / Dichtring: NBR
EPDM
Viton
Silikon
PTFE

Komponents / Komponenten

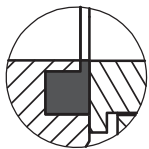

Detail gasket
Detail der Dichtung

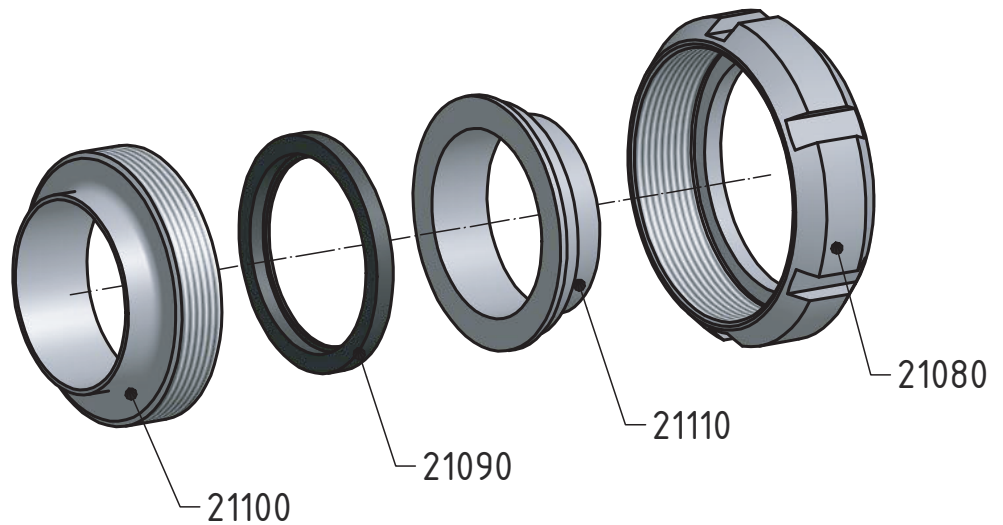

Standard gasket /Standard Dichtring - EPDM

Welding union - complete
Anschweißverschraubung - komplett

21120

Dimensions • Baumaße

SMS

DN	A	B	C	D	E	F	R	L	thread DIN 405 Rd x s	kg
25	35,5	22,5	25		51				40x1/6	0,18
38	40	35,5	38		74				60x1/6	0,47
51	41	48,5	50,8		84				70x1/6	0,55
63,5	45	60,5	63,5		100				85x1/6	0,83
76	47	72,9	76,1		114				98x1/6	1,13
101,6	50	97,6	101,6		138				125x1/4	2,78
104	50	100	104		138				125x1/4	2,78

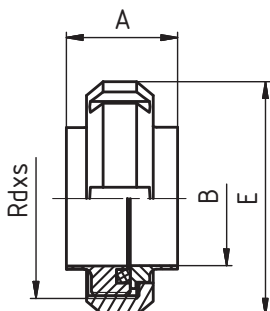

Clamp union - S - DIN
Clampverbindung - S - DIN

21250

Description
Beschreibung

DIN 32 676



Clamp union - S - DIN 21250

- Simple instalation
- Easy gasket exchange

Clampverbindung - S - DIN 21250

- Einfache die Dichtung austauschen
- Einfache Installation

Dimensions / Baumaße: DN 10 - DN 150

Material / Material: 1.4301 (AISI 304)
1.4404 (AISI 316L)

Gasket / Dichtring: Silikon
PTFE - Viton
Viton
EPDM

Komponents / Komponenten



Detail gasket
Detail der Dichtung

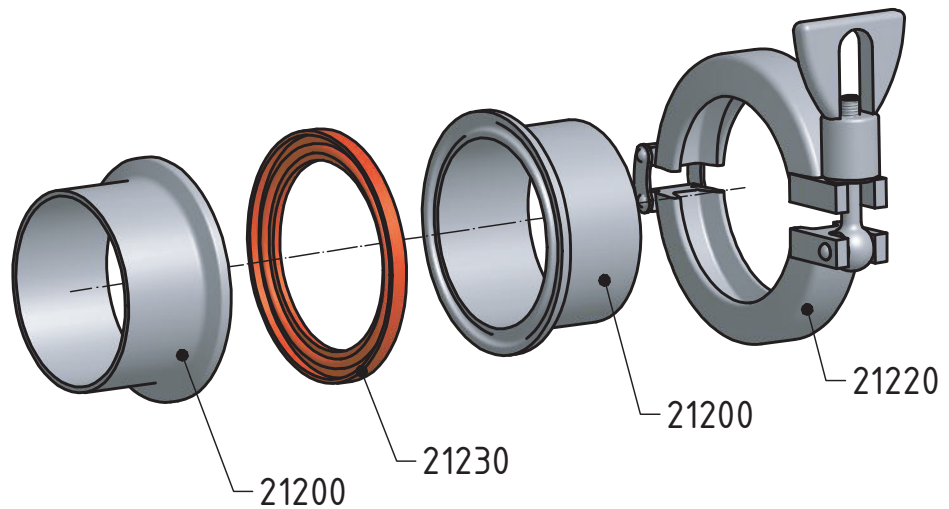

Standard gasket /Standard Dichtring - Silikon

Clamp union - S - DIN - complete
Clampverbindung - S - DIN - komplett

21250

Dimensions • Baumaße

DIN 32 676

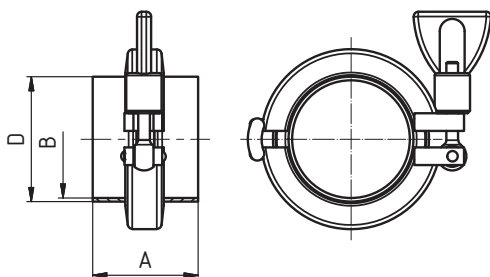

DN	A	B	C	D	E	F	R	L	thread DIN 405 Rd x s	kg
10	45	10		13						0,28
15	45	16		19						0,28
20	45	20		23						0,30
25	45	26		29						0,35
32	45	32		35						0,35
40	45	38		41						0,37
50	45	50		53						0,39
65	58	66		70						0,89
80	58	81		85						0,95
100	58	100		104						0,99
125	58	125		129						1,15
150	58	150		154						1,30

Clamp union - S - SMS
Clampverbindung - S - SMS

21252

Description
Beschreibung

SMS



Clamp union - S - SMS 21252

- Simple instalation
- Easy gasket exchange

Clampverbindung - S - SMS 21252

- Einfache die Dichtung austauschen
- Einfache Installation

Dimensions / Baumaße: DN 10 - DN 150

Material / Material: 1.4301 (AISI 304)
1.4404 (AISI 316L)

Gasket / Dichtring: Silikon
PTFE - Viton
Viton
EPDM

Komponents / Komponenten



Detail gasket
Detail der Dichtung

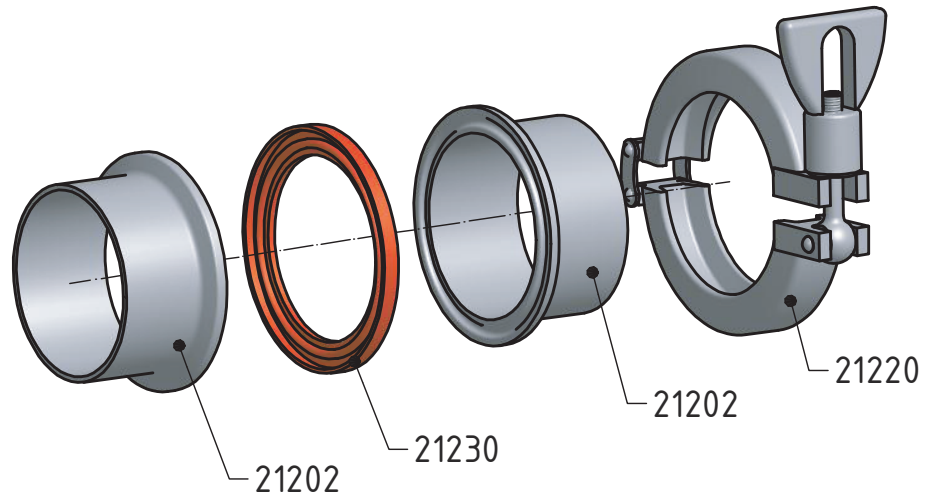

Standard gasket /Standard Dichtring - Silikon

Clamp union - S - SMS - complete
Clampverbindung - S - SMS - komplett

21252

Dimensions • Baumaße

SMS

DN	A	B	C	D	E	F	R	L	thread DIN 405 Rd x s	kg
25	43	22,5		25						0,35
38	43	35,5		38,1						0,37
51	43	48,5		51						0,39
63,5	56	60,5		63,5						0,89
76	56	72,9		76,1						0,95
101,6	56	97,6		101,6						0,99

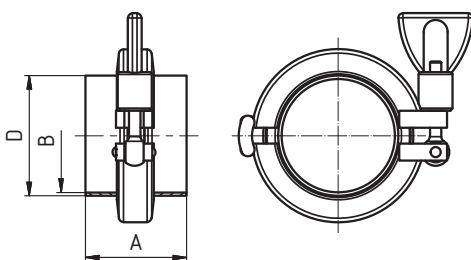

Welding union
Anschweißverschraubung

22320

Description
Beschreibung

DIN 11 853



Welding union 22320, DIN 11 853-1

- Simple instalation
- Easy gasket exchange

Anschweißverschraubung 22320, DIN 11 853-1

- Einfache die Dichtung austauschen
- Einfache Installation

Baumaße / Dimensions: DN 10 - DN 100

Thread / Gewinde: DIN 405

Material / Material: 1.4301 (AISI 304)

1.4404 (AISI 316L)

Dichtring / Gasket:

NBR
EPDM
Viton

Komponents / Komponenten

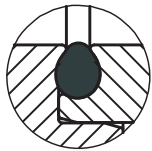

Detail gasket
Detail der Dichtung

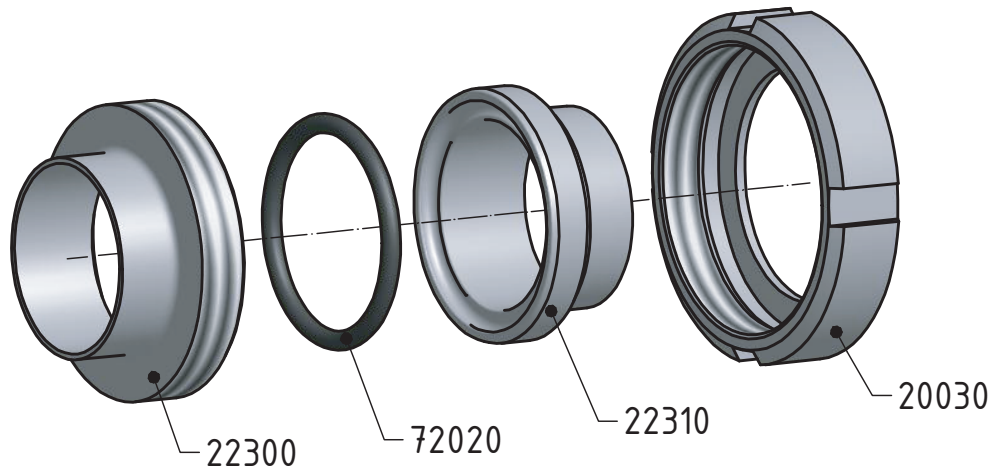

Standard gasket /Standard Dichtring - EPDM

Welding union - complete
Anschweißverschraubung - komplett

22320

Dimensions • Baumaße

DIN 11 853

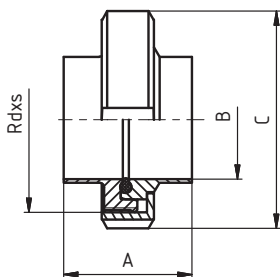

DN	A	B	C	D	E	F	R	L	thread DIN 405 Rd x s	kg
10	32	10	38						28 x 1/8"	0,14
15	32	16	44						34 x 1/8"	0,18
20	34	20	54						44 x 1/6"	0,30
25	42	26	63						52 x 1/6"	0,41
32	48	32	70						58 x 1/6"	0,48
40	50	38	78						65 x 1/6"	0,57
50	54	50	92						78 x 1/6"	0,78
65	62	66	112						95 x 1/6"	1,27
80	72	81	127						110 x 1/4"	1,76
100	86	100	148						130 x 1/4"	2,40

Welding union
Anschweißverschraubung

22490
DIN 11 864-1-A

Description
Beschreibung



Welding union 22490, DIN 11 864-1

- Simple instalation
- Easy gasket exchange

Anschweißverschraubung 22490, DIN 11 864-1

- Einfache die Dichtung austauschen
- Einfache Installation

Baumaße / Dimensions: DN 10 - DN 100

Thread / Gewinde: DIN 405

Material / Material: 1.4301 (AISI 304)
1.4404 (AISI 316L)

Dichtring / Gasket: NBR
EPDM
Viton

Komponents / Komponenten

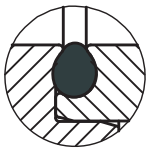

Detail gasket
Detail der Dichtung

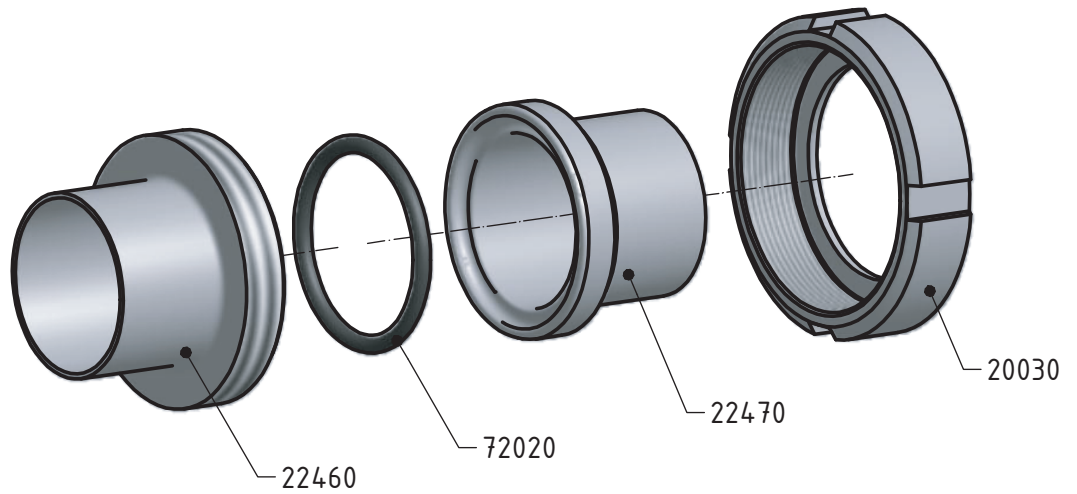

Standard gasket /Standard Dichtring - EPDM

Welding union - complete
Anschweißverschraubung - komplett

22490

Dimensions • Baumaße

DIN 11 864-1-A

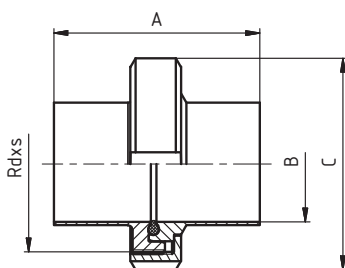

DN	A	B	C	D	E	F	R	L	thread DIN 405 Rd x s	kg
10	76	10	38						28x1/8"	0,08
15	76	16	44						34x1/8"	0,11
20	76	20	54						44x1/6"	0,19
25	77	26	63						52x1/6"	0,26
32	88	32	70						58x1/6"	0,31
40	88	38	78						65x1/6"	0,36
50	89	50	92						78x1/6"	0,50
65	113	66	112						95x1/6"	0,86
80	117	81	127						110x1/4"	1,16
100	120	100	148						130x1/4"	1,51

Flange connection PN 10
Flanschverbindung PN 10

20720
DIN 2576

Description
Beschreibung

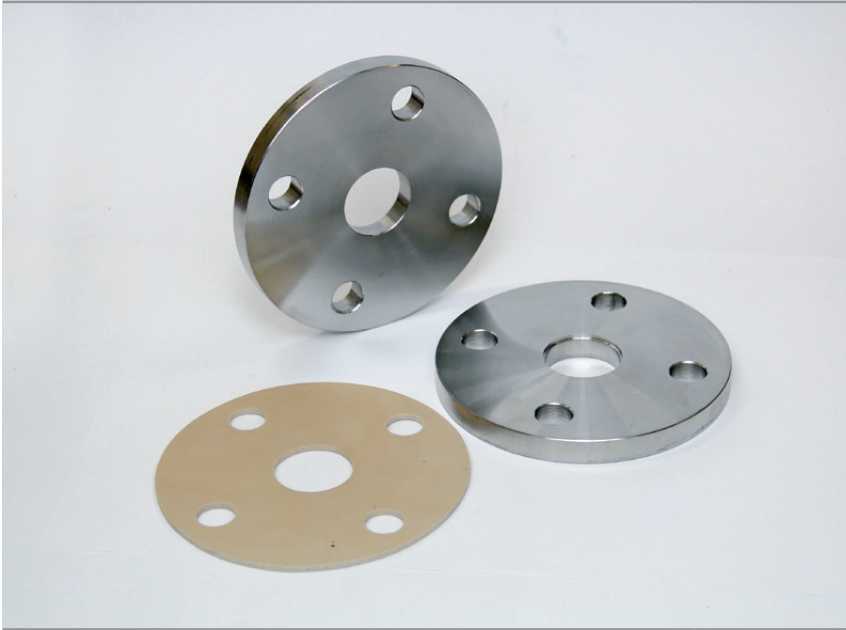

Flange connection PN 10
- Simple instalation
- Easy gasket exchange

Flanschverbindung PN 10
- Einfache installation
- Einfache die Dichtung austauschen

Dimensions / Baumaße: DN 10 - DN 150

Material / Material: 1.4301 (AISI 304)
1.4404 (AISI 316L)

Gasket / Dichtring: NBR
EPDM
Viton

Komponents / Komponenten



Detail gasket
Detail der Dichtung

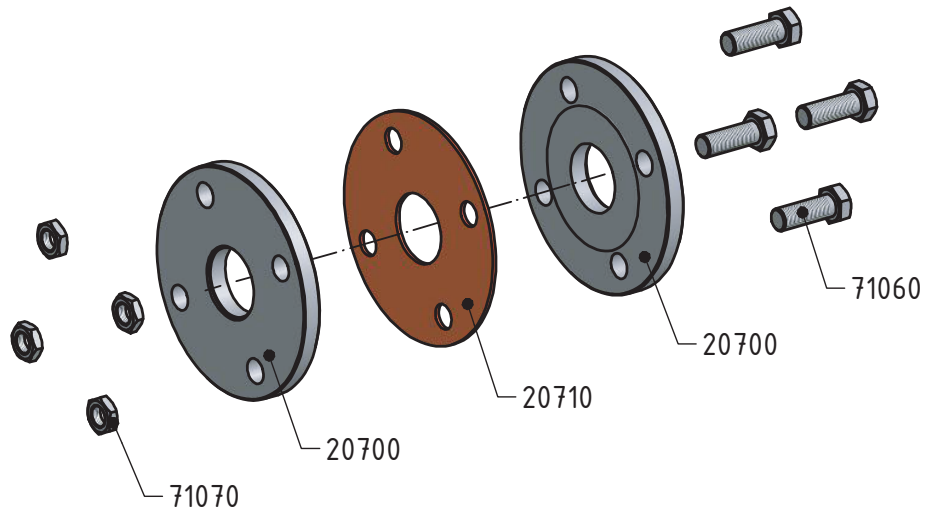

Standard gasket / Standard Dichtring - NBR

Flange connection PN 10 - complete
Flanschverbindung PN 10 - komplett

20720
DIN 2576

Dimensions • Baumaße

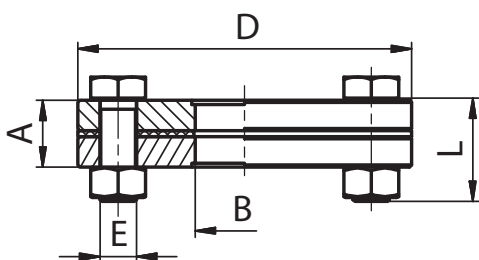

DN	A	B	C	D	E	F	R	L	Rd x s	kg
10	31	10		90	4 x M12			40		1,30
15	31	16		95	4 x M12			40		1,40
20	31	20		105	4 x M12			45		2,00
25	31	26		115	4 x M12			45		2,30
32	31	32		140	4 x M16			50		3,50
40	31	38		150	4 x M16			50		4,00
50	31	50		165	4 x M16			55		5,10
65	32	66		185	4 x M16			55		6,00
80	36	81		200	8 x M16			55		7,50
100	36	100		220	8 x M16			55		8,30
125	44	125		250	8 x M16			60		13,00
150	52	150		285	8 x M20			65		16,70

Flange connection PN 16
 Flanschverbindung PN 16

20740
Description
 Beschreibung

DIN 2633

Flange connection PN 16 DIN 2633

- Simple instalation
- Easy gasket exchange

Flanschverbindung PN 16 DIN 2633

- Einfache installation
- Einfache die Dichtung austauschen

Dimensions / Baumaße: DN 10 - DN 150

Material / Material: 1.4301 (AISI 304)
 1.4404 (AISI 316L)

Gasket / Dichtring: NBR
 EPDM
 Viton

Komponents / Komponenten

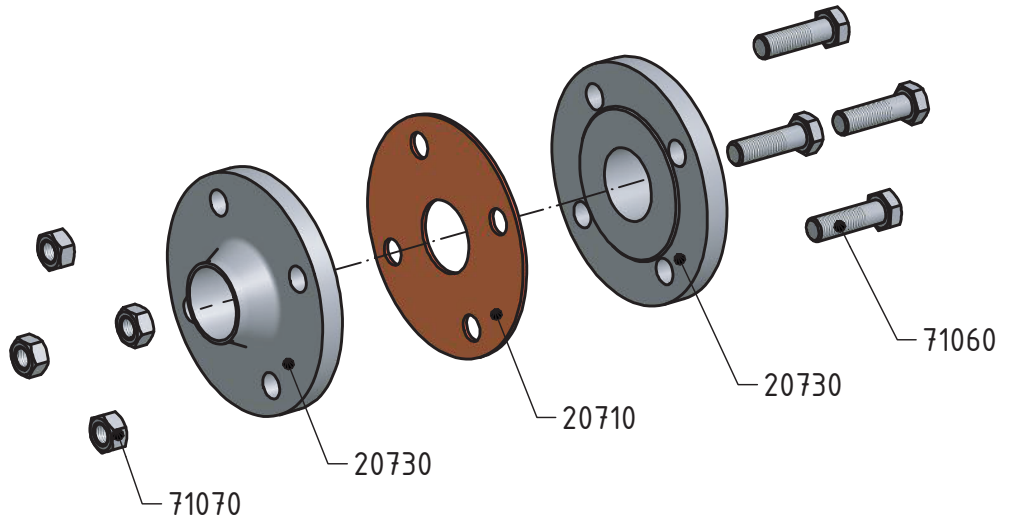
 Detail gasket
 Detail der Dichtung

Standard gasket /Standard Dichtring - NBR

Flange connection PN 16 - complete
 Flanschverbindung PN 16 - komplett

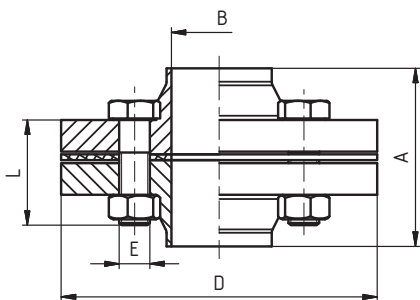
20740
Dimensions • Baumaße
DIN 2633

DN	A	B	C	D	E	F	R	L	thread DIN 405 Rd x s	kg
10	73	10		90	4 x M12			45		1,16
15	73	16		95	4 x M12			45		1,30
20	79	20		105	4 x M12			45		1,90
25	79	26		115	4 x M12			50		2,28
32	83	32		140	4 x M16			50		3,20
40	88	38		150	4 x M16			50		3,60
50	94	50		165	4 x M16			55		5,06
65	94	66		185	4 x M16			55		6,12
80	104	81		200	8 x M16			60		7,40
100	108	100		220	8 x M16			60		9,24
125	114	125		250	8 x M16			65		12,60
150	114	150		285	8 x M20			70		15,5

Flange connection complete PN 10
 Flanschverbindung komplett PN10

20420
Description
 Beschreibung

Flange connection PN 10

- Simple instalation
- Easy gasket exchange

Flanschverbindung PN 10

- Einfache installation
- Einfache die Dichtung austauschen

Dimensions / Baumaße: DN 10 - DN 150

Material / Material: 1.4301 (AISI 304)
 1.4404 (AISI 316L)

Gasket / Dichtring: NBR
 EPDM
 Viton

Komponents / Komponenten

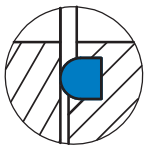
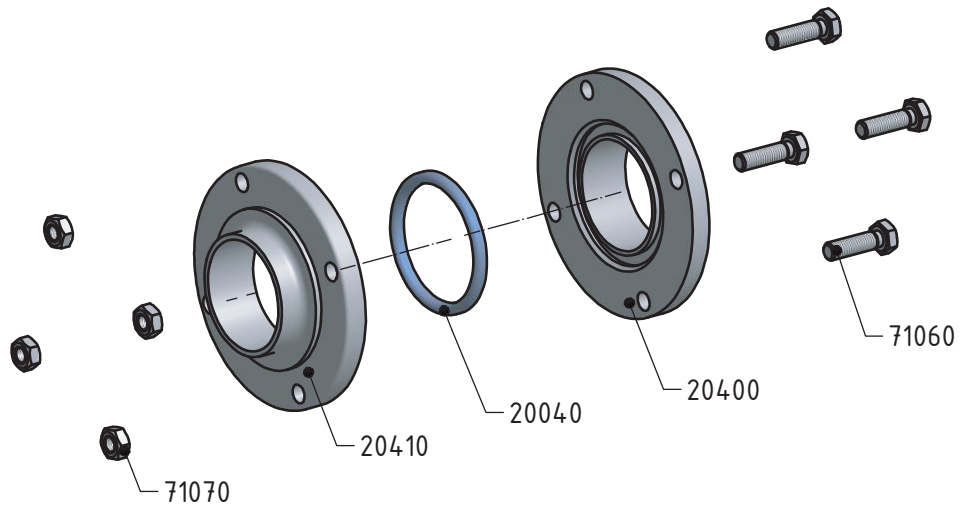
 Detail gasket
 Detail der Dichtung

Standard gasket /Standard Dichtring - NBR

Flange connection PN 10 - complete
 Flanschverbindung PN 10 - komplett

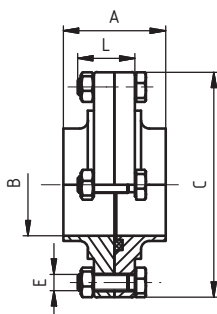
20420
Dimensions • Baumaße

DN	A	B	C	D	E	F	R	L	thread DIN 405 Rd x s	kg
10	40	10	62		4 x M8			28		0,40
15	40	16	68		4 x M8			28		0,52
20	40	20	75		4 x M8			28		0,58
25	40	26	87		4 x M8			28		0,78
32	40	32	92		4 x M8			28		0,92
40	50	38	97		4 x M8			28		0,94
50	50	50	110		4 x M8			28		1,18
65	50	66	127		4 x M8			28		1,50
80	60	81	142		4 x M8			40		2,56
100	60	100	162		4 x M8			40		3,44
125	80	125	200		6 x M10			45		5,74
150	90	150	230		6 x M10			45		7,70

Hygienic flange connection PN10
Hygiene flanschverbindung PN 10

22870

Description
Beschreibung

DIN 11 853



Hygienic flange connection PN10 DIN 11853

- Simple instalation
- Easy gasket exchange

Hygiene flanschverbindung PN 10 DIN 11853

- Einfache installation
- Einfache die Dichtung austauschen

Dimensions / Baumaße: DN 10 - DN 150

Material / Material: 1.4301 (AISI 304)
1.4404 (AISI 316L)

Gasket / Dichtring: EPDM
Viton

Komponents / Komponenten



Detail gasket
Detail der Dichtung

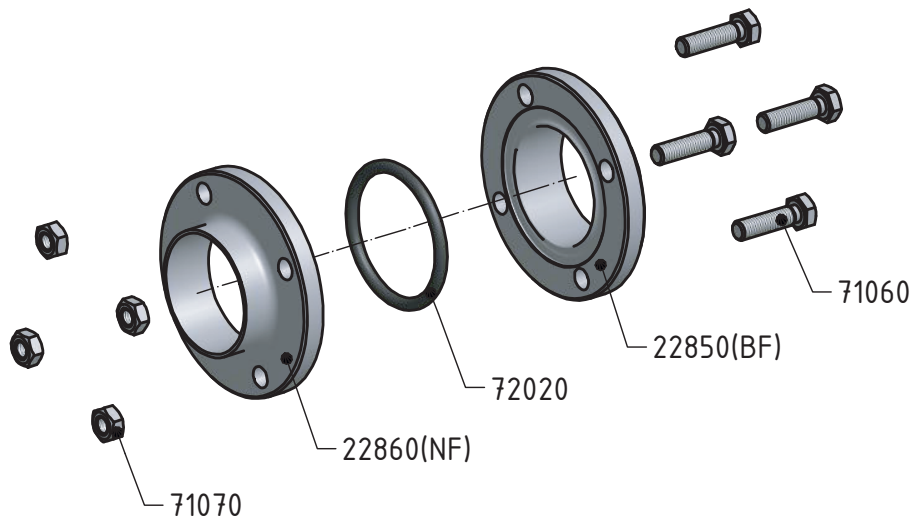

Standard gasket /Standard Dichtring - EPDM

Hygienic flange connection PN10 - complete

22870

Dimensions • Baumaße

Hygiene flanschverbindung PN 10 -komplett

DIN 11 853

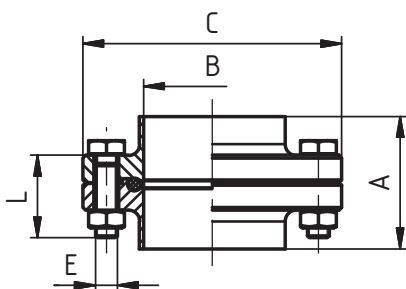

DN	A	B	C	D	E	F	R	L	thread DIN 405 Rd x s	kg
10	48	10	54		4 x M8			28		0,41
15	48	16	59		4 x M8			28		0,46
20	48	20	64		4 x M8			28		0,52
25	48	26	70		4 x M8			28		0,60
32	48	32	76		4 x M8			28		0,66
40	48	38	82		4 x M8			28		0,73
50	48	50	94		4 x M8			28		0,87
65	48	66	113		8 x M8			28		1,21
80	52	81	133		8 x M10			35		1,96
100	52	100	159		8 x M10			40		2,97
125	56	125	183		8 x M10			40		3,47
150	56	150	213		8 x M12			45		5,02

Aseptic flange connection PN 10
Aseptic flanschverbindung PN 10

22930
DIN 11 864-2-A

Description
Beschreibung



Aseptic flange connection PN 10 DIN 11864
- Simple instalation
- Easy gasket exchange

Aseptic flanschverbindung PN 10 DIN 11864
- Einfache installation
- Einfache die Dichtung austauschen

Dimensions / Baumaße: DN 10 - DN 150

Material / Material: 1.4301 (AISI 304)
1.4404 (AISI 316L)

Gasket / Dichtring: EPDM
Viton

Komponents / Komponenten

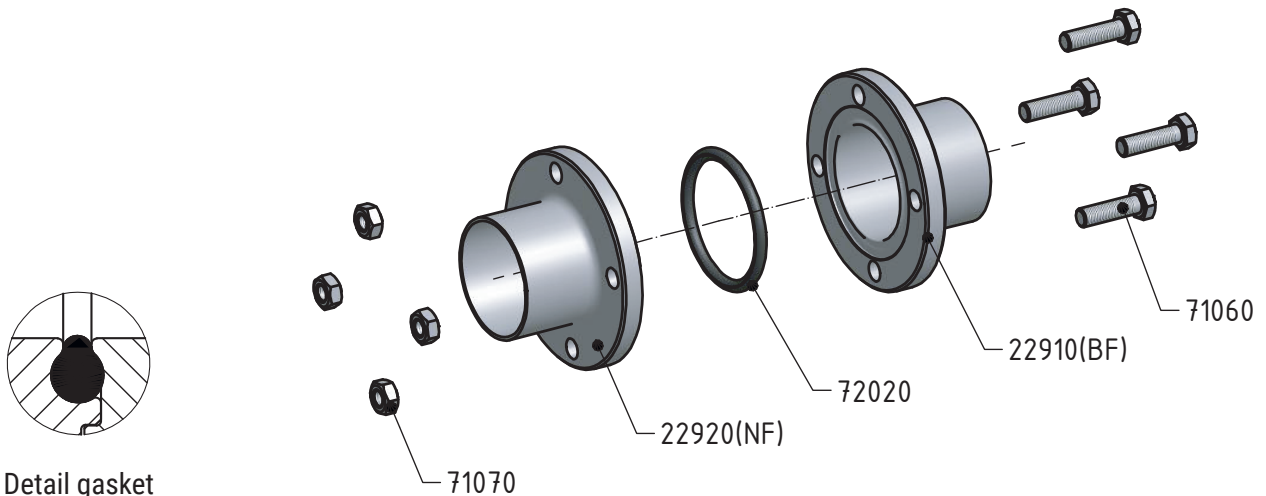

Detail gasket
Detail der Dichtung

Standard gasket /Standard Dichtring - EPDM

Aseptic flange connection PN10 - complete
Aseptic flanschverbindung PN 10 - komplett

22930

Dimensions • Baumaße

DIN 11 864-2-A

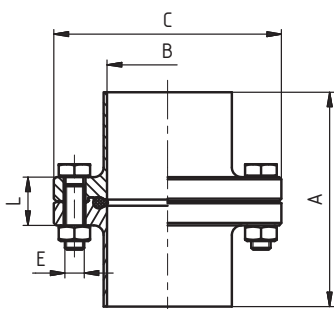

DN	A	B	C	D	E	F	R	L	thread DIN 405 Rd x s	kg
10	80	10	54		4 x M8			28		
15	80	16	59		4 x M8			28		
20	80	20	64		4 x M8			28		
25	80	26	70		4 x M8			28		
32	90	32	76		4 x M8			28		
40	90	38	82		4 x M8			28		
50	90	50	94		4 x M8			28		
65	108	66	113		8 x M8			28		
80	116	81	133		8 x M10			35		
100	116	100	159		8 x M10			40		
125	120	125	183		8 x M10			40		
150	120	150	213		8 x M12			45		

Clamp union S DIN 11964-3
Clampverbindungen S DIN 11864-3

22970

DIN 11864-3

Description
Beschreibung

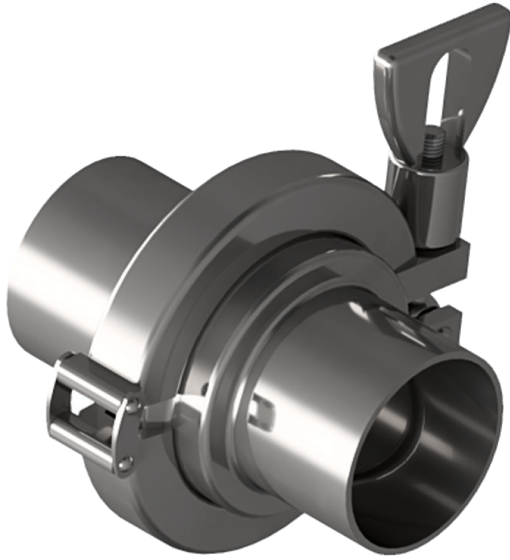

Clamp union - S - DIN 11864-3

- Simple instalation
- Easy gasket exchange

Clampverbindung - S - DIN 11864-3

- Einfache die Dichtung austauschen
- Einfache Installation

Dimensions / Baumaße: DN 10 - DN 100

Material / Material: 1.4404 (AISI 316L)

Gasket / Dichtring: Silikon, EPDM, PTFE / Viton

Komponents / Komponenten

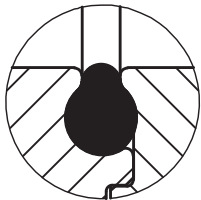

Detail gasket
Detail der Dichtung

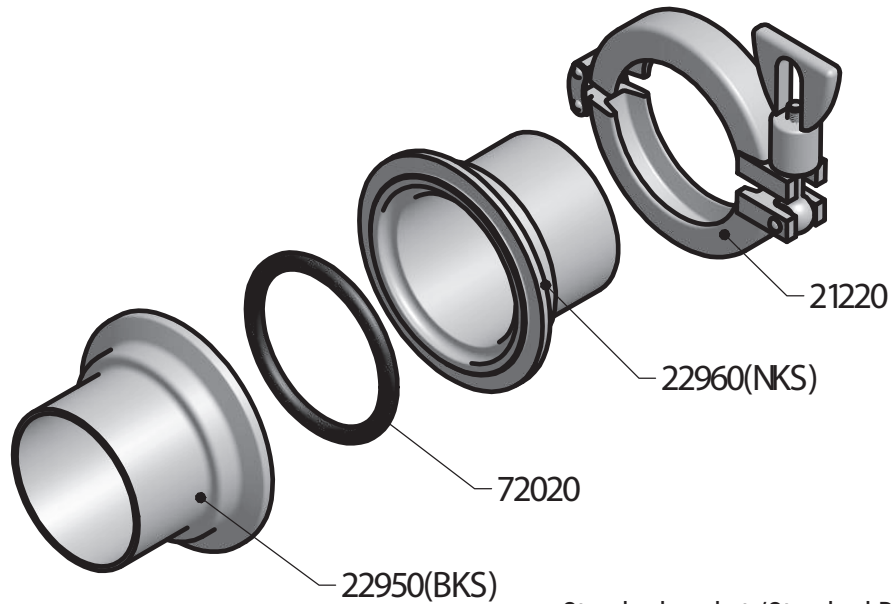

Standard gasket / Standard Dichtring
- Silikon, EPDM, PTFE - Viton

Clamp union S DIN 11964-3
- complete

Clampverbindungen S DIN 11864-3
- komplett

22970

Dimensions • Baumaße

DIN 11864-3

DN	A	B	C	D	E	F	R	L	thread DIN 405 Rd x s	kg
10	77,5	10	13							
15	77,5	16	19							
20	77,5	20	23							
25	78,5	26	29							
32	89,5	32	35							
40	89,5	38	41							
50	90,5	50	53							
65	114,5	66	70							
80	118,5	81	85							
100	121,5	100	104							

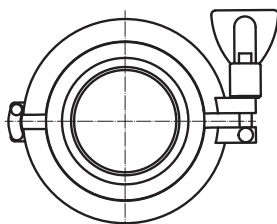
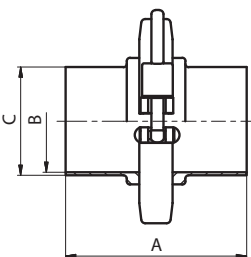

CONVERSION TABLE		UMRECHNUNGSTABELLE	
DN	(inch)	(mm)	
8	1/4"	6,35	
10	3/8"	9,25	
15	1/2"	12,7	
20	3/4"	19,0	
25	1"	25,4	
32	1 1/4"	31,7	
40	1 1/2"	38,1	
50	2"	51,0	
65	2 1/2"	63,5	
80	3"	76,1	
100	4"	104,0	

BAR CONVERSION CHARTS	BAR UMPRECHNUNGSTABELLE
<h1>1 Bar</h1>	100000 Pascals
	100 Kilopascals
	1000 Milibars
	1000000 Microbars
	~0,98 Atmospheres
	~401,46 Inches of wather
	10 Meters of wather
	~29,53 Inches of mercury
	~750 Milimeters of mercury
	~14,5 Pounds per square inches
	~1,02 Kilograms per square inches

MATERIALS USED

All units and parts listed in this catalogue are produced from non-corrosive acid-resistant Cr – Ni steel ČSN 17 240, which is the equivalent of the German standard DIN 1.4301. If the corrosion-proof requirements of the parts are higher they are produced from non-corrosive Cr-Ni-Mo steel ČSN 17 349 which conforms to DIN 1.4404.

Chemical composition of the most frequently used non-corrosive steels

ČSN PN	%C max.	%Si max.	%Mn max.	%P max.	%S max.	%Cr max.	%Mo max.	%Ni max.	%Ti max.
17 240	0.07	1.00	2.00	0.045	0.030	17.0-20.0	-	9.0 -11.5	-
17 249	0.03	1.00	2.00	0.045	0.030	17.0-20.0	-	10.0-12.5	-
17 346	0.07	1.00	2.00	0.045	0.030	16.5-18.5	2.0-2.5	10.5-13.5	-
17349	0.03	1.00	2.00	0.045	0.030	16.5-18.5	2.0-2.5	11.0-14.0	-
17 248	0.10	1.00	2.00	0.045	0.030	17.0-19.0	-	9.5-12.0	>=5xC
17 348	0.10	1.00	2.00	0.045	0.030	16.5-18.5	2.0-2.5	11.0-14.0	>=5xC

International standards conversion table for marking steels

Poldi	Czech Rep. PN	Germany DIN (W. Nr.)	USA ASTM	Italy UNI	France AFNOR	Russia GOST
AKV7	17240	1.4301	AISI 304	X5CrNi1810	Z7CN18-09	08Ch18N10
AKV2	17249	1.4306	AISI304L	X2CrNi1811	Z3CN19-121	03Ch18N11
AKV EX7	17346	1.4401	AISI 316	X5CrNiMo1712.2	Z7CND17-12-02	-
AKV EX2	17349	1.4404	AISI 316L	X2CrNiMo1713.2	Z3CND18-12-02	03Ch12N14M2
AKVS7	17248	1.4541	AISI 321	X6CrNiTi1811	Z6CNT18-10	08Ch18N10T
AKV EX S9	17348	1.4571	AISI 316Ti	X6CrNiMoTi1712	Z6CNDT17-12	08Ch17N13M2

DESIGN

The bulk of products are produced from bars or forged material. The material is in such a state that after welding it is not necessary to carry out further treatment. Tubular adapting pipes in their basic finish are pickled – matt, or treated – ground (brushed).

PIPE CONNECTING PARTS – DIN SCREW COUPLINGS

These are produced according to the DIN 11 851 standard and the screw thread according to the DIN 405 (ČSN 01 4037) standard. Connection of the sockets (screw thread or ring) to the tubes can be done in two ways:

- butt welding
- flaring the inside diameter

From diameters of 50mm and above it is necessary to ensure flaring of connections with a seam weld. Flared connections with a seam weld are hygienically unobjectionable and are suitable for pressures of 1 MPa (tested at a pressure of 2 MPa). Parts which do not correspond to any standards are produced according to branch or factory standards, and possibly workshop standards, and in some cases to approved technical drawings.

SEALING

Seals listed in this catalogue are produced from the following materials – SILICON, PERBUNAN, EPDM or VITON. They are supplied separately or as part of the set. Prices for tubular adapting pipes and sets of screw couplings do not include sealing rings.

MAINTENANCE

Without exception the materials used are suitable for general use in the food-processing industry. These materials are sensitive to high concentrations of chloride solutions and therefore we recommend that the instructions and recommendations of the manufacturer are heeded. Corrosion can only be prevented if these instructions are adhered to.

SPECIAL DESIGN

Apart from the standard parts listed in this catalogue we also supply special designs according to customer requirements and their technical documentation.

INSTRUCTIONS FOR ORDERING

For quick and simple processing of your order please supply the following data:

1	2	3	4
numerical labelling of goods	dimension(DN)	material	amount

If group „3” is not listed in the order we automatically supply material 17 240 (DIN 1.4301)

If you require other parts and units than those in this catalogue please send your specific requirements.

This issue nullifies all previous catalogues and delivery conditions listed in them.

We would be pleased to discuss your specific requirements and answer your questions in person. We look forward to your visit.

Technical Information for Gaskets					
Title	Silicon (VMQ silicon rubber)	EPDM (ethylene-propylene-diene rubber)	Viton (FPM fluorine rubber)	Perbunan (NBR nitrile rubber)	PTFE (polytetrafluorethylene)
Temperature of use	It is stable in water up to 100 °C Possibility of sterilisation by steam short-term up to 120 °C to 130 °C	Permanent operating use from 40 °C to +140 °C Possibility of sterilisation by steam up to 130 °C	Permanent operating use from 20 °C to +200 °C Possibility of sterilisation by steam short-term up to 130 °C to 140 °C	Permanent operating use from 25 °C to +110 °C Possibility of sterilisation by steam short-term up to 130 °C	Up to +200 °C it is physiologically harmless, use from 200 °C to +260 °C
Recommended use	High temperature load capacity It has good resistance to cold, suitable for food, it has dielectric properties. It has good resistance to alcohols.	It has good resistance to swelling for: • Diluted inorganic and organic acids, media, oxidising media, lyes, and ketones • Hot water and steam up to 130 °C	It has good resistance to swelling for: • Mineral oils • Plant and animal oils • Lubricants (also some additives) • Fuels	It has good resistance to swelling for: • Aliphatic hydrocarbons (such as propane, butane, benzene, mineral oil) • Lubricants based on mineral oil	It has good resistance to swelling in almost all parts It has a smooth and repellent surface so sticking does not occur It has better chemical resistance than in all other elastomers Non-flammable material
Limited use (border)	Shows high swelling for: • Low-molecular esters and ethers • Aliphatic and aromatic hydrocarbons • Concentrated acids and alkali	Cannot be used for: • Plant and animal oils • Aliphatic, aromatic, and chlorinated hydrocarbons • Mineral oils	Shows high swelling for: • Polar solvents, such as acetone, methyl ketone, ethyl acetate, diethyl ether, and dioxane • Low-molecular organic acids (formic acid and acetic acid) • Gaseous ammonia, amines and alkanes • Overheated water steam	Not resistant to: • Polar solvents • Chlorinated hydrocarbons • Ketones • Aromatic hydrocarbons (benzol) • Esters	Not resistant to: • Liquid alkaline metals and some compounds of fluorine in connection with higher pressure and temperature The material does not show the flexibility of rubber.
Material approval	BGA/FDA	BGA/FDA	BGA/FDA	BGA/FDA	BGA/FDA
BGA = approval of the "Federal Health Authority" in Germany ("Bundesgesundheitsamt") FDA = approval of the "US Food and Drug Administration"					

Technische Informationen für Dichtringe					
Name	Silikon (VMQ)	EPDM (Ethylen-Propylen-Dien-Kautschuk)	Viton (FPM)	Perbunan (NBR)	PTFE (Polytetrafluoräthylen)
Einsatztemperatur	in Wasser bis 100°C beständig Dampfsterilisierbar kurzfristig bis 120°C - 130°C	Dauereinsatz von minus 40°C bis 140°C Dampfsterilisierbar bis 130°C	Dauereinsatz von minus 20°C bis 200°C Dampfsterilisierbar kurzfristig bis 130°C - 140°C	Dauereinsatz von minus 25°C bis 110°C Dampfsterilisierbar kurzfristig bis 130°C	bis 200°C physiologisch unbedenklich, Einsatz von -200°C bis +260°C
typ. Einsatzbereich	hohe thermische Belastbarkeit gute Kältebeständigkeit, für lebensmittel gut geeignet, dielektrische Eigenschaft gute Beständigkeit gegenüber Alkoholen	gute Quellbeständigkeit bei: • verdünnte anorg.- und organische Säuren, Medien, oxidierend wirkende Medien, Laugen und Kationen • in Heißwasser und Dampf bis 130°C	gute Quellbeständigkeit bei: • Mineralölen • pflanzlichen und tierischen Ölen • Fetten (auch bestimmte Additive) • Kraftstoffe	gute Quellbeständigkeit • aliphatischen Kohlenwasserstoffen (wie Propan, Butan, Benzin, Mineralölen) • Fett auf Mineralölbasis	gute Quellbeständigkeit in nahezu allen Teilen Oberfläche glatt und abweisend, dadurch kein Haften von Rückständen chemische Beständigkeit besser als bei allen anderen Elastomeren kaum brennbar
Einsatzgrenzen	hohe Quellung bei: • niedermolekularen Estern und Ethern • aliphatischen und aromatischen Kohlenwasserstoffen • konz. Säuren und Alkalien	nicht einzusetzen bei: • pflanzlichen und tierischen Ölen • aliphatischen aromatischen und chlorierten Kohlenwasserstoffen • Mineralöle	stark quellend bei: • polaren Lösungsmitteln wie Aceton, Methylketon, Ethylacetat, Diethylether u. Dioxane • niedermolekularen organ. Säuren (Ameisen- und Essigsäuren) • Ammoniakgase, Amine u. Alkanien • überhitzter Wasserdampf	nicht beständig bei: • polaren Lösungsmitteln • chlorierten Kohlenwasserstoffen • Ketone • Aromaten (Benzol) • Ester	nicht beständig bei: • flüssigen Alkalimetallen und einigen Flourverbindungen in Verbindung mit hohem Druck und Temperatur kein gummielastischer Werkstoff
Werkstoffzulassung	BGA/FDA	BGA/FDA	BGA/FDA	BGA/FDA	BGA/FDA
BGA = Bundesgesundheitsamt FDA = US Food and Drug Administration					



PRODUCER OF STAINLESS PIPING SYSTEMS
HERSTELLER VON EDELSTAHLARMATUREN

NIOB FLUID s. r. o.
Ostrožská 1003
687 25 Hluk
Czech Republic

Phone: +420 572 419 822 – 8
Fax: +420 572 419 868
E-mail: marketing@niobfluid.cz

www.niobfluid.cz